

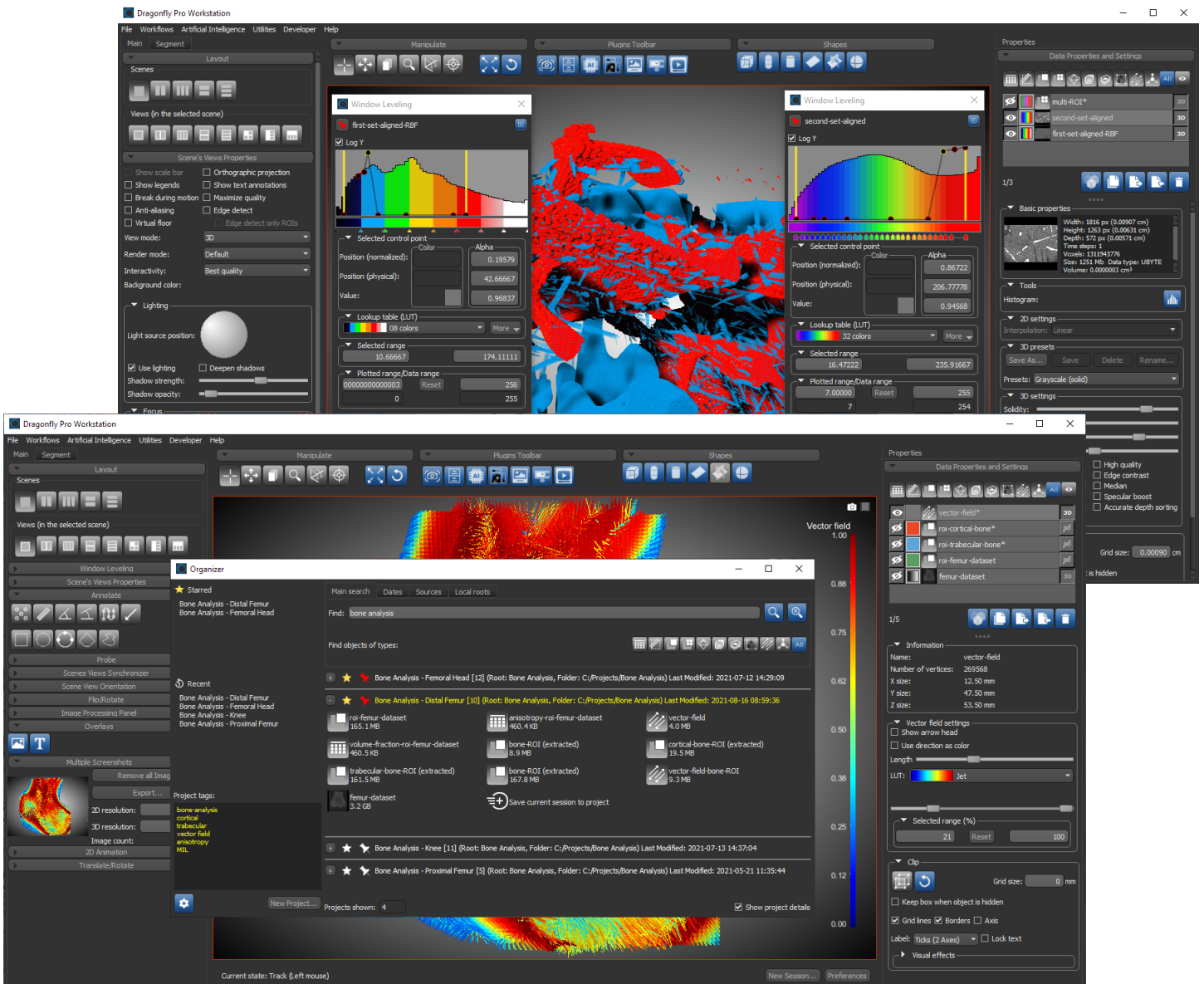

# DRAGONFLY 2021.3 RELEASE NOTES



## **COPYRIGHT**

© 2021 Object Research Systems (ORS) Inc. ORS is member of the Comet Group. All rights reserved.

The present end-user documentation is confidential and proprietary information of Object Research Systems (ORS) Inc. ("ORS"). Only licensees of ORS have a right to use the information contained herein. Only licensees have the right to copy and/or transfer the information for internal use, unless otherwise agreed with ORS. Any unauthorized use, disclosure, transfer or reproduction of this confidential information may give rise to a right in ORS to seek a legal remedy against such use, disclosure, transfer or reproduction.

Except as expressly provided otherwise in writing, the information provided in this document is provided AS IS, without any condition or warranty, whether written, oral, implied, legal, or statutory. ORS makes no warranty as to its accuracy. Any use of the documentation or the information contained herein is at the risk of the user. Documentation may include technical or other inaccuracies or typographical errors. Information is subject to change without notice.

## **TRADEMARKS**

Object Research Systems, the ORS logo, Dragonfly, and the Dragonfly logo are trademarks of Object Research Systems (ORS) Inc.

## **THIRD-PARTY TRADEMARKS**

Anaconda is a trademark or registered trademark of Anaconda, Inc. Python is trademark or registered trademark of the Python Software Foundation. Adobe, Acrobat, Flash, and Reader are either registered trademarks or trademarks of Adobe Systems Incorporated in the United States and/or other countries. NVIDIA and GeForce are registered trademarks or trademarks of NVIDIA Corporation in the United States and/or other countries. Microsoft and Windows are either registered trademarks or trademarks of Microsoft Corporation in the United States and/or other countries. Advanced Micro Devices, AMD, and ATI are either registered trademarks or trademarks of Advanced Micro Devices Incorporated in the United States and/or other countries. All other brand names, product names, or trademarks belong to their respective holders and should be noted as such.

## **NOTICES**

Powered with Anaconda Distribution™ from Anaconda, Inc.

Portions of Dragonfly's 3D engine licensed from the University of Münster.

Dragonfly is intended for research use only. It is NOT a medical device.

## **COVER IMAGES**

Dragonfly's updated Organizer (bottom) and reformatted Window Leveling panels pinned to multi-modality datasets of a carbide sample (top).



**Title** Dragonfly 2021.3 Release Notes  
**Release date** 2021-08-31  
**Reference number** TM021-A-10

# Contents

*This document describes the new features, product enhancements, and other improvements implemented in the Dragonfly and Dragonfly Pro 2021.3 software release. You should read these release notes before you install this new version.*

<b>New Features and Product Enhancements</b> . . . . .	<b>6</b>
Organizer . . . . .	6
Window Leveling Panel with LUT Editor . . . . .	8
LUT Editor (Histogram and Control Points) . . . . .	9
Color Mapping . . . . .	11
Opacity Mapping . . . . .	11
Measurement Inspector . . . . .	13
Segmentation Wizard . . . . .	14
Monitor Model Training . . . . .	14
Image Modalities . . . . .	15
Training Parameters for Deep Models . . . . .	15
Changes for Working with Frames . . . . .	17
Models Tab . . . . .	19
Model Generation Strategies . . . . .	20
Deep Learning Tool . . . . .	21
Monitoring Model Training . . . . .	21
Setting Regions for Visual Feedback . . . . .	22
Enabling Checkpoint Caches . . . . .	23
Loading and Saving Model Checkpoints . . . . .	23
Filter with AI . . . . .	25
Machine Learning Segmentation . . . . .	26
Segment with AI . . . . .	27
Intensity Scale Calibrations . . . . .	28
Dimension Unit Manager . . . . .	29
Creating New Dimension Units . . . . .	29
Creating Calibration Standards . . . . .	29
Image Properties (Dimension Units) . . . . .	30
Spatial Scale Calibrations . . . . .	31
Scalar Generator . . . . .	32
Scalar Values for Multi-ROIs . . . . .	32
Measurements and Scalar Values for Meshes . . . . .	34
Measurements and Scalar Values for Graphs . . . . .	35
Scalar Values for Vector Fields . . . . .	36

- Annotations . . . . . 37
  - Ruler Properties . . . . . 37
  - Arrow Properties . . . . . 40
  - Scale Bar Properties . . . . . 41
- Histogram Analysis . . . . . 42
- MC X-Ray . . . . . 43
  - Simulation Results . . . . . 43
  - Specimen Generator . . . . . 44
- Non-Planar Views . . . . . 45
  - Extracting Non-Planar Views from Spheres or Cylinders . . . . . 45
  - Cylindrical Projections . . . . . 46
  - Spherical Projections . . . . . 46
  - Extracting Non-Planar Views from Curved Planes . . . . . 48
  - Painting in Non-Planar Views . . . . . 49
  - Extracting Non-Planar Projections . . . . . 49
  - Configured Actions for Non-Planar Views . . . . . 50
- 3D Renderings and 3D Views . . . . . 51
  - Virtual Floor . . . . . 51
  - Isosurface Renderings . . . . . 52
  - Using Focus . . . . . 53
  - Show 3D Cursor . . . . . 53
  - Render 2D View Planes . . . . . 54
  - Axis Indicator . . . . . 54
- Clipping . . . . . 55
- Regions of Interest . . . . . 56
  - Applying LUTs . . . . . 56
  - Visualizations without Image Data . . . . . 56
  - Creating Images from Scalars . . . . . 57
  - ROI Painter . . . . . 58
- Graphs and Vector Fields . . . . . 58
- Meshes . . . . . 59
  - Thickness Analyses . . . . . 59
  - Mesh Capping . . . . . 60
- Shapes . . . . . 61
- Movie Maker . . . . . 62
- Screen Recorder . . . . . 62
- Artificial Data Generator . . . . . 63
- Padding . . . . . 64
- CT Reconstruction . . . . . 65
- Hyperspectral Imaging . . . . . 65
- Customizing Workspaces . . . . . 65
- Menu Bar Changes . . . . . 66
  - File Menu . . . . . 66
  - Artificial Intelligence Menu . . . . . 66
  - Utilities Menu . . . . . 66
- Changes to Contextual Menus . . . . . 67
  - Dataset Pop-Up Menu . . . . . 67
  - ROI Pop-Up Menu . . . . . 67
  - Multi-ROI Pop-Up Menu . . . . . 67

- Mesh Pop-Up Menu . . . . . 68
- Graph Pop-Up Menu . . . . . 68
- Vector Field Pop-Up Menu . . . . . 68
- Annotations Pop-Up Menu . . . . . 68
- Shapes Pop-Up Menu . . . . . 69
- Preferences Changes . . . . . 69
  - Views Preferences . . . . . 69
  - Organizer Preferences . . . . . 69
  - Configurable Actions . . . . . 70
  - Deep Learning Preferences . . . . . 70
- Resolved Issues . . . . . 71
- System Requirements . . . . . 71
- TensorFlow . . . . . 72
- Extending Dragonfly . . . . . 73
- Requesting New Features . . . . . 73
- Learning Dragonfly . . . . . 73
  - Dragonfly Workshops . . . . . 73
  - Online Training . . . . . 73
- Reporting Issues . . . . . 74

## New Features and Product Enhancements

The 2021.3 software release for **Dragonfly** and **Dragonfly Pro** provides significant enhancements for the Organizer, Window Leveling, and Segmentation Wizard, as well as new surface inspection tools, calibration workflows, and measurement options.

### Organizer

Dragonfly's **Organizer**, which is enterprise ready for centralizing data within an institute, now features a new look and new options for organizing data-intensive projects. Organizer, which is equipped with drag-and-drop functionality for adding objects from a project to the current session and vice-versa, now includes the options to 'Star' and 'Pin' frequently referenced projects. Recently accessed projects also appear on the newly implemented left sidebar.

Choose **File > Open the Organizer** on the menu bar to open the Organizer dialog, shown below.

Organizer dialog

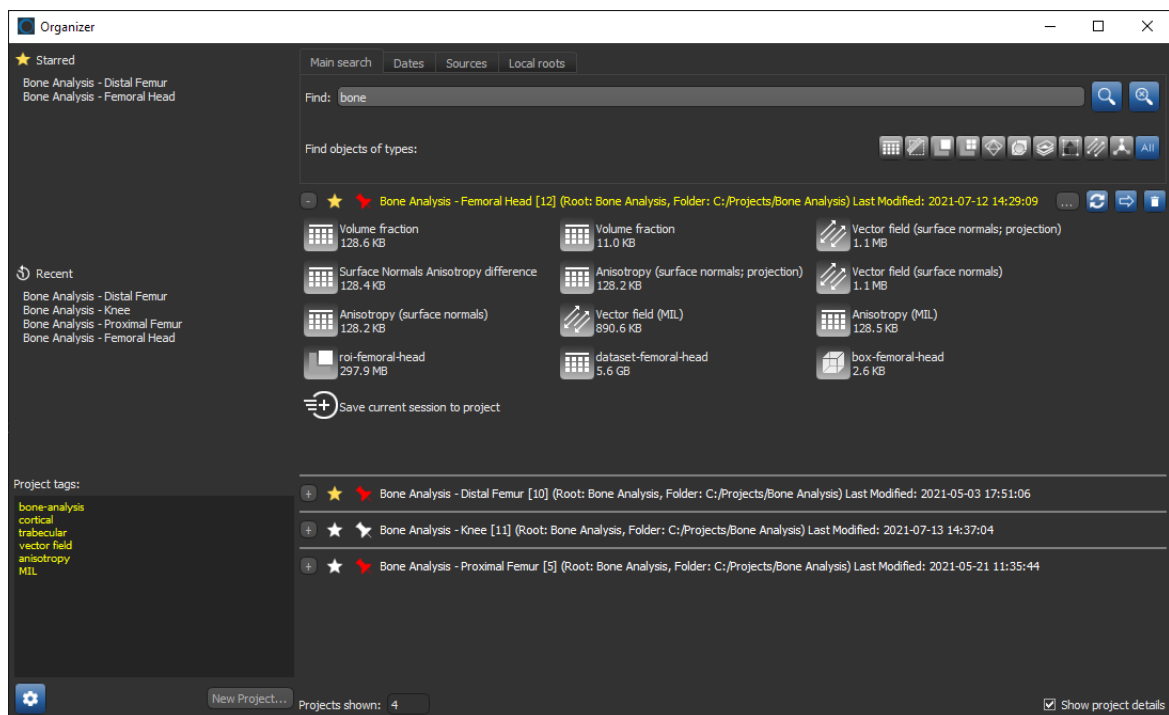

Organizer's new interface includes a large search results panel that incorporates a number of new options for viewing and organizing projects, as well as a left sidebar that lists Starred and Recent projects, project tags, and lets you access the Settings dialog.

**Starred...** Quickly access frequently referenced data by 'starring' projects. Starred projects appear in an easy-to-access list on the left sidebar.

**Recent...** Recently accessed projects are listed here. If required, you clear the Recent list by right-clicking and then choosing **Clear Recent List**.

**Settings...** New options in the Organizer Settings dialog, shown below, let you set the size of icons and text.

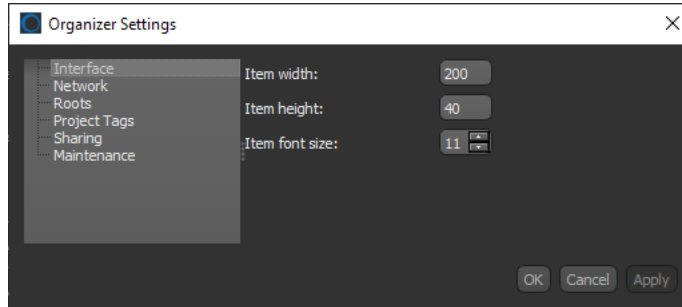

A number of new options are available for each project listed in the search results panel. You should note that each project can be expanded to view the available data or collapsed to maximize space, as shown below.

Expanded and collapsed project listings

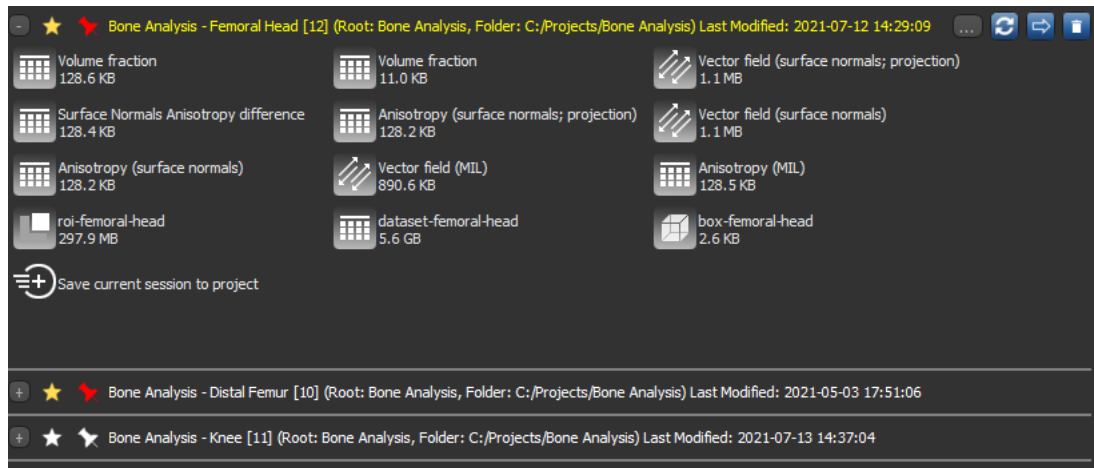

**Starred...** Click the **Star** icon to add a project the easy-to-access 'Starred' list on the left sidebar.

**Pinned...** Click the **Pin** icon to pin a project. Pinned projects will appear at the top of the project list at all times.

**Title...** Includes the project name and additional information, if **Show project details** is checked.

A number of additional items are available on hover for renaming projects, updating objects that are open in the current scene, moving projects, and deleting projects.

You should also note that you can now **drag-and-drop trained models** between the Organizer and the Deep Learning Tool and Machine Learning Segmentation dialogs and vice versa. This lets you easily share models with other users on your network, as well as provides the option to archive models with their training sets.

## Window Leveling Panel with LUT Editor

This Dragonfly release consolidates window leveling functions with LUT editing capabilities, along with a number of 2D/3D settings previously available on the Data Properties and Settings panel, within a reformatted Window Leveling panel.

The refactored Window Leveling panel, shown in the following screen capture, features:

- Selection of LUTs and tools for LUT editing, as well as color mapping and opacity mapping modes.
- Piecewise opacity mode, as shown on the histogram below, with selectable color and alpha control points and a color control point editor.
- New options for creating duplicate panels and pinning a panel to a selected dataset and scene view.

Window Leveling panel

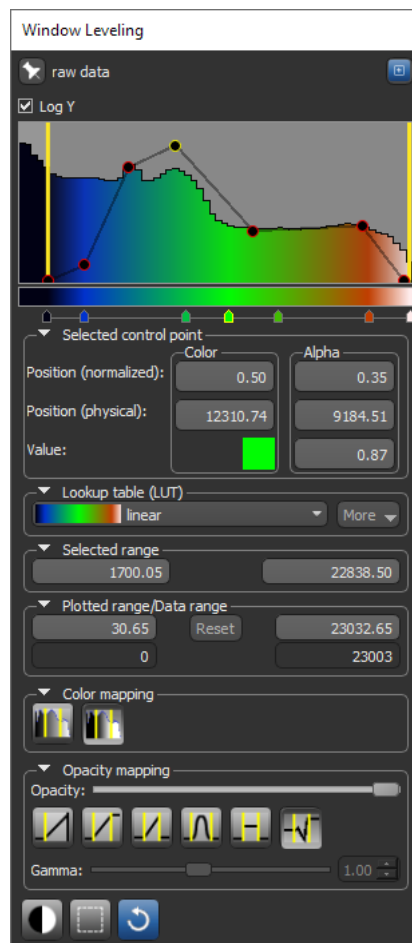

**Pin...** In cases in which you are working with multiple datasets, you can 'pin' the Window Leveling panel controls for LUT editing, color mapping, and opacity mapping to a selected dataset.

**Open...** Click the "+" icon to create an additional instance of the Window Leveling panel, which can be 'pinned' to another dataset.



## LUT Editor (Histogram and Control Points)

Dragonfly's look-up table (LUT) functions, which determine how regions within specific arrays of intensity are displayed and colored, can now be applied and edited directly in the Window Leveling panel to optimize the 2D and 3D views of datasets. Depending on which LUT you choose, the difference between the original and remapped version can be subtle or very dramatic.

The integrated LUT Editor, shown below, displays a plot of the current image's look-up table (LUT) that describes the shade or color that is displayed for each of the possible pixel values, as well as its opacity. When set to "Piecewise", control points are inserted into the histogram that highlight regions within specific arrays of intensity. By manipulating the color and alpha control points, the best overall contrast between various features can be achieved. You can edit any of the available LUTs, as well as create your own.

Histogram and control points

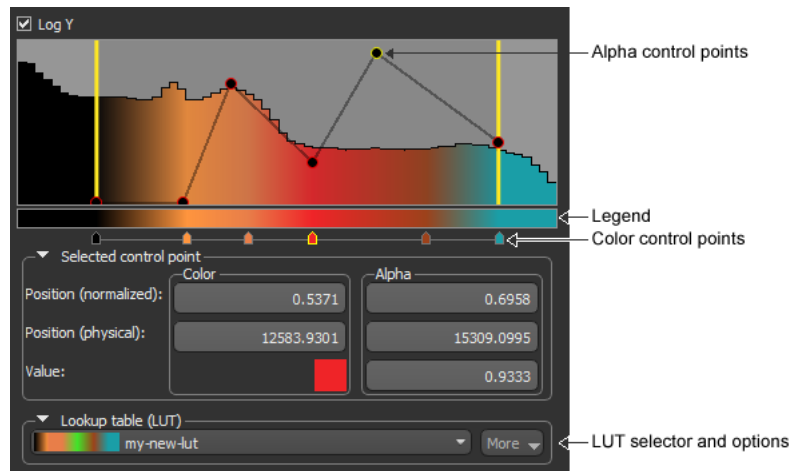

**NOTE** The LUT Editor that was available in previous Dragonfly versions was deprecated for this software release. You can now edit a LUT directly in the Window Leveling panel, as described below.

**Alpha control points...** Determines the opacity — from transparent to fully opaque — of a region. The normalized position of the control point within the selected window, its physical position (the value to which it corresponds), as well as the control point's alpha value, are indicated in the Selected control point box.

**Legend...** Displays the shades or colors of the selected LUT.

**Color control points...** Determines the shade or color applied to a region. The normalized position of the control point within the selected window, its physical position (the value to which it corresponds), as well as the control point's color or colors, are indicated in the Selected control point box.

Click the color swatch to open the Color Control Point Editor dialog. You can choose a color for a control point in the dialog, as well as choose to split a control point and then pick colors for the lower and higher values.

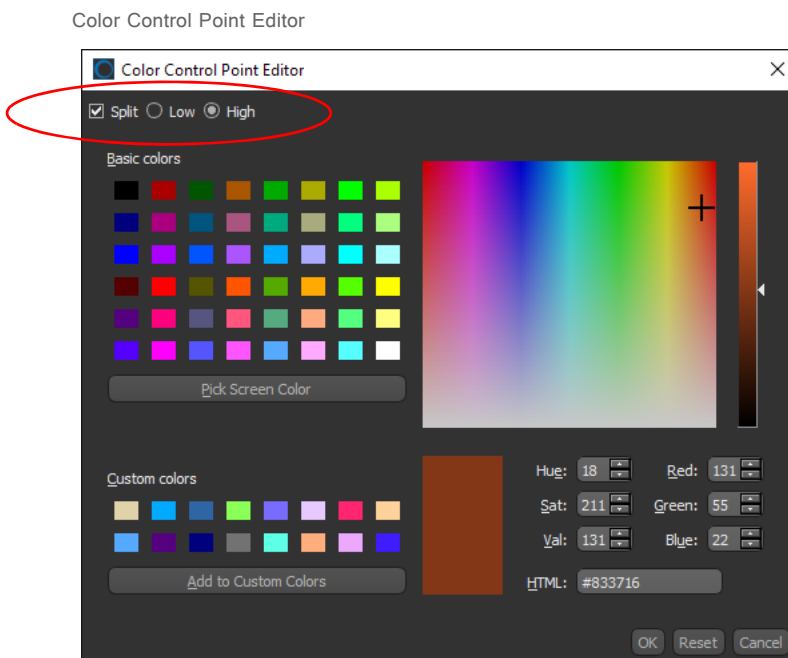

**Lookup table (LUT)...** The controls in the Lookup table (LUT) box let you choose a LUT to apply to the selected data, as well as access options for distributing color points, flipping the position of the control points, converting the alpha values to piecewise, importing LUT settings, as well as resetting and saving LUTs.



The **More** button provides access to the following options:

	Description
Distribute Color Control Points Equally	Automatically distributes the color control points equally — either between the data range, if 'Map to full range' is selected as the LUT mapping mode, or within the window, if 'Map to Window' is selected as the LUT mapping mode.
Flip Color Control Points Position (Horizontal Flip)	Automatically flips the position of the color control points horizontally.
Edit Discrete LUT	Opens the Discrete LUT Editor dialog, in which you modify the colors of a discrete LUT.
Distribute Alpha Control Points Equally	Automatically distributes the alpha control points equally — either between the data range, if 'Map to full range' is selected as the LUT mapping mode, or within the window, if 'Map to Window' is selected as the LUT mapping mode.
Flip Alpha Control Points Position (Horizontal Flip)	Automatically flips the position of the alpha control points horizontally.
Flip Alpha Control Points Value (Vertical Flip)	Automatically flips the value of the alpha control points. For example, an initial value of 0.70 will become 0.30 when it is flipped.
Sample Alpha as Piecewise	Automatically adds alpha control points to the current window leveling mode as per the current alpha distribution. <b>NOTE</b> Not available if the current window leveling mode is 'Piecewise'.
Import LUT Settings	Lets you import and apply the settings of another LUT to the current LUT.
Revert to Saved LUT	Resets the LUT back to its last-saved settings.
Save LUT As	Lets you save a new version of the selected LUT.
Delete LUT	Lets you delete a custom LUT. <b>NOTE</b> You cannot delete any of the default LUTs.

## Color Mapping

You can choose two options for mapping LUT colors and shades to intensity values — **Map to full data range** or **Map to selected window** — in the Color mapping box.

Color mapping options

		Description
Map to full data range		If selected, color mapping will be applied independently of window leveling. This means that shades and colors mapped to specific values will be retained whenever leveling values are changed.
Map to selected window		If selected, colors will be mapped to the range of values defined by the window width.

## Opacity Mapping

Previously available in the 3D settings box on the Data Properties and Settings panel, the Opacity slider lets you adjust the global opacity of a dataset, while you can choose a mapping mode in the Opacity mapping box.





Opacity mapping box



**NOTE** The Opacity Console that was available in previous Dragonfly versions was deprecated for this software release.

The following Opacity mapping modes are available for 3D views in this software release.



Opacity mapping modes for 3D views

Mode	Icon	Description
Left-gated ramp		In this mode, the opacity of the values to the left of the lower threshold will be set to 0, while the upper threshold is disabled. The opacity of the values within the window will be set within a linear ramp, which can be modified by adjusting the gamma.
Bi-gated ramp		In this mode, the opacity of the values to the left of the lower threshold will be set to 0, while the opacity of the values to the right of the upper threshold will be set as per the highest value within the window. The opacity of the values within the window will be set within a linear ramp, which can be modified by adjusting the gamma.
Bandpass ramp		In this mode, the opacity of the values to the left of the lower threshold and to the right of the upper threshold will be set to 0. The opacity of the values within the window will be set within a linear ramp, which can be modified by adjusting the gamma.
Bandpass Gaussian		In this mode, the opacity of the values to the left of the lower threshold and to the right of the upper threshold will be set to 0. The opacity of the values within the window will be set within a Gaussian window. <b>NOTE</b> Gamma cannot be adjusted in this mode.
Bandpass constant		In this mode, the opacity of the values to the left of the lower threshold and to the right of the upper threshold will be set to 0. The opacity of the values within the window will set to a constant 50%. <b>NOTE</b> Gamma cannot be adjusted in this mode.

Mode	Icon	Description
Piecewise		In this mode, the opacity of the values within the window will be set to the value of the alpha control points, while the opacity of the values to the left of the lower threshold will be set as per the leftmost control point and the opacity of the values to the right of the upper threshold will be set as per the rightmost control point.  <b>NOTE</b> You can convert other modes, such as Bi-gated ramp or Bandpass Gaussian to 'Piecewise' by choosing <b>More &gt; Sampled Alpha as Piecewise</b> .  <b>NOTE</b> Gamma cannot be adjusted in this mode.

The following Opacity Mapping modes are available for 2D views in this software release.

Opacity mapping modes for 2D views

Mode	Icon	Description
Allpass constant		In this mode, the opacity of the values within the window will set to a constant 50%.  <b>NOTE</b> Gamma cannot be adjusted in this mode.
Bi-gated ramp		In this mode, the opacity of the values to the left of the lower threshold will be set to 0, while the opacity of the values to the right of the upper threshold will be set as per the highest value within the window. The opacity of the values within the window will be set within a linear ramp, which can be modified by adjusting gamma.
Piecewise		In this mode, the opacity of the values within the window will be set to the value of the alpha control points, while the opacity of the values to the left of the lower threshold will be set as per the leftmost control point and the opacity of the values to the right of the upper threshold will be set as per the rightmost control point.  <b>NOTE</b> You can convert other modes, such as Bi-gated ramp or Bandpass Gaussian to 'Piecewise' by choosing <b>More &gt; Sampled Alpha as Piecewise</b> .  <b>NOTE</b> Gamma cannot be adjusted in this mode.

## Measurement Inspector

Changes related to LUT editing that were implemented for the Window Leveling panel (see [LUT Editor \(Histogram and Control Points\)](#) on page 9) are also available for the Measurement Inspector, as shown below. You can open the Measurement Inspector by right-clicking a multi-ROI, scalar mesh, graph, or vector field and then choosing **Measurement Inspector** in the pop-up menu.

Measurement Inspector

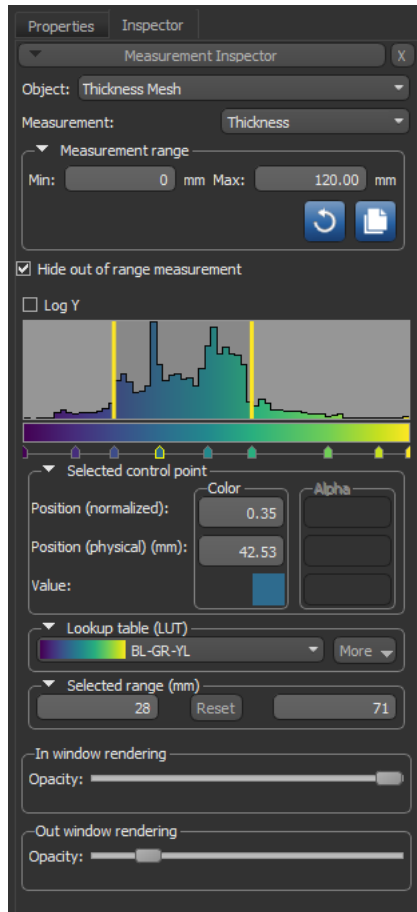

**NOTE** The Measurement Inspector lets you plot the scalar values of an object and then highlight selected ranges in the available 2D and 3D scene views.

## Segmentation Wizard

The following new features and updates are available for the Segmentation Wizard in this software release.

### Monitor Model Training

To help monitor and evaluate the progress of training deep models in the Segmentation Wizard, you can designate a frame for visual feedback. With the Visual Feedback option selected, the model's inference will be displayed in the Model Training dialog in real time as each epoch is completed, as shown on the right of the screen capture below. In addition, you can create a checkpoint cache so that you can save a copy of the model at a selected checkpoint (see [Enabling Checkpoint Caches](#) on page 23 and [Loading and Saving Model Checkpoints](#) on page 23). Saved checkpoints are marked in bold on the plotted graph, as shown below.

Training dialog

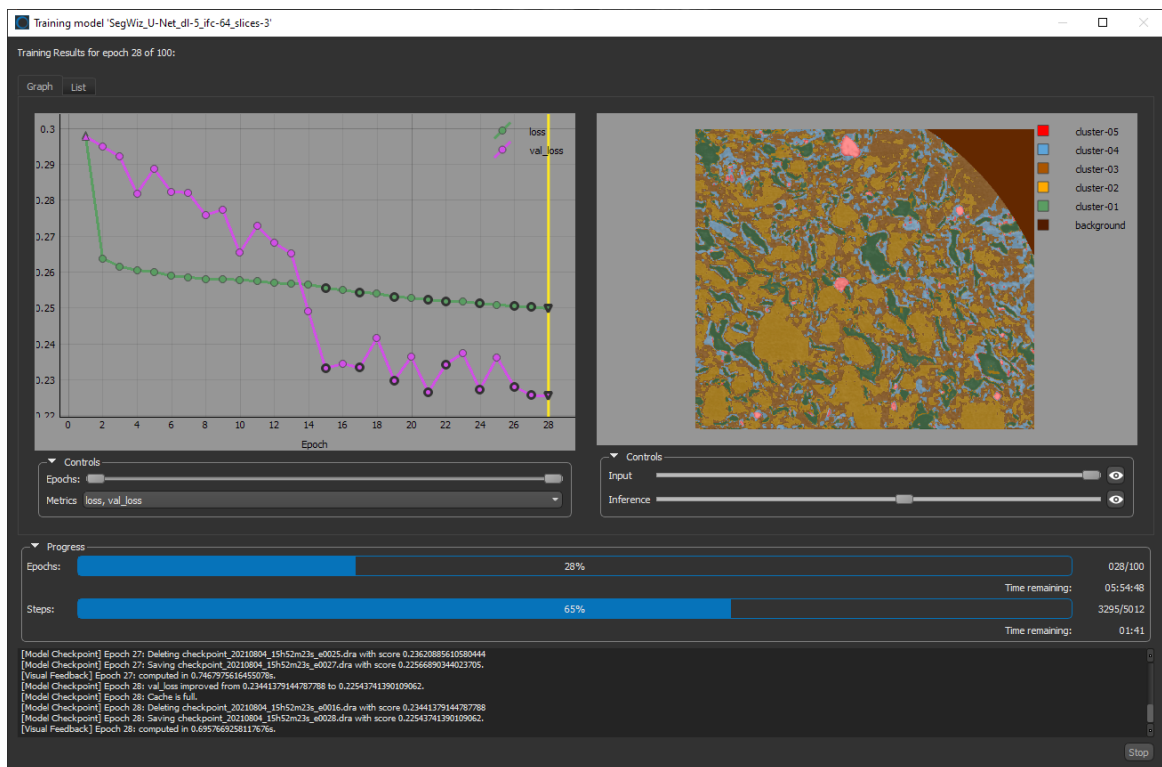

Do the following to enable visual feedback during training:

- Add a frame to a representative slice that does not include labeled training data.
- Click the **Enable Frame for Visual Feedback** button in the Frames list, as shown.

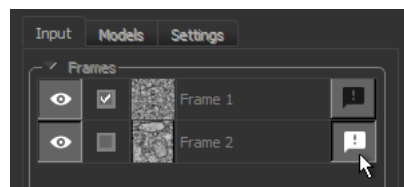

## Image Modalities

When working with multi-modality models, you can now reorder and rename your datasets in the Image modalities prior to training. To reorder an item, simply drag it up or down in the list, as shown below.

Reordering of image modalities

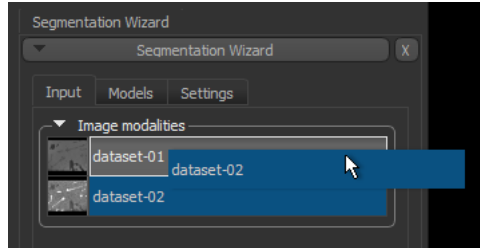

## Training Parameters for Deep Models

This software release features additional training parameters for deep models, which are available in the reformatted Training Parameters dialog. Right-click a model and then choose **Update Training Parameters** to open the dialog, shown in the following screen capture. You should note that the Training Parameters dialog now includes three tabs — **Settings**, **Advanced Settings**, and **Data Augmentation**.

Training Parameters dialog

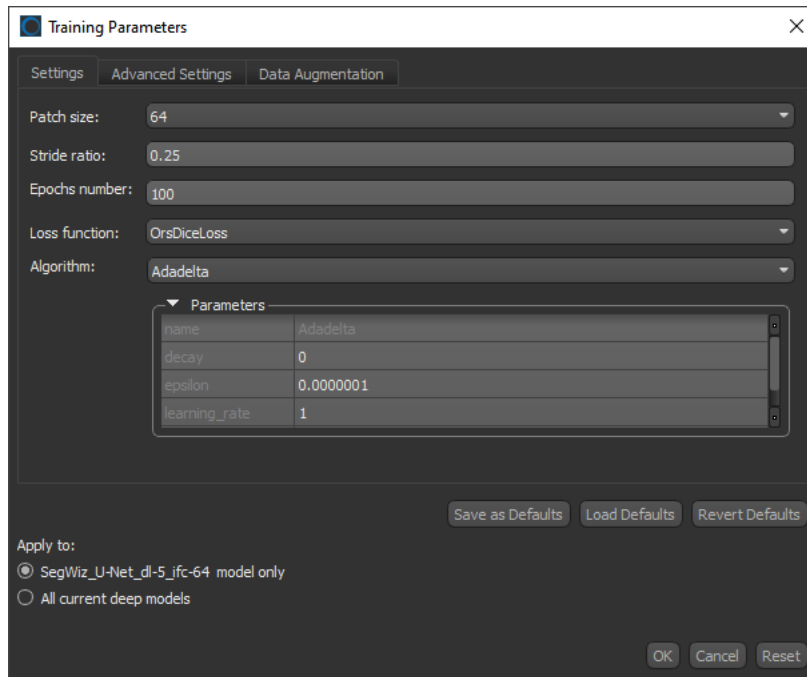

**Settings...** The basic settings for training a deep model are available on the Settings tab. These include patch size, stride ratio, and epochs number, as well as loss function and optimization algorithm.

You should note that data is now split to sample proportionally from each class instead of proportionally from all the data with a minimum of one patch per area. For example, if you had 3 patches in 2021.1, they would have been sampled into training, test, and

validation all having a single patch, regardless of labeling. That split would not be possible in 2021.3 if one of the patches does not contain all of the classes, since at least one area would be missing at least one class.

**Advanced Settings...** This new set of training parameters, which are available on the Advanced Settings tab shown below, lets you set learning rate patience and cooldown as a fraction of the available training data available, as well as early stopping patience.

Advanced Settings tab

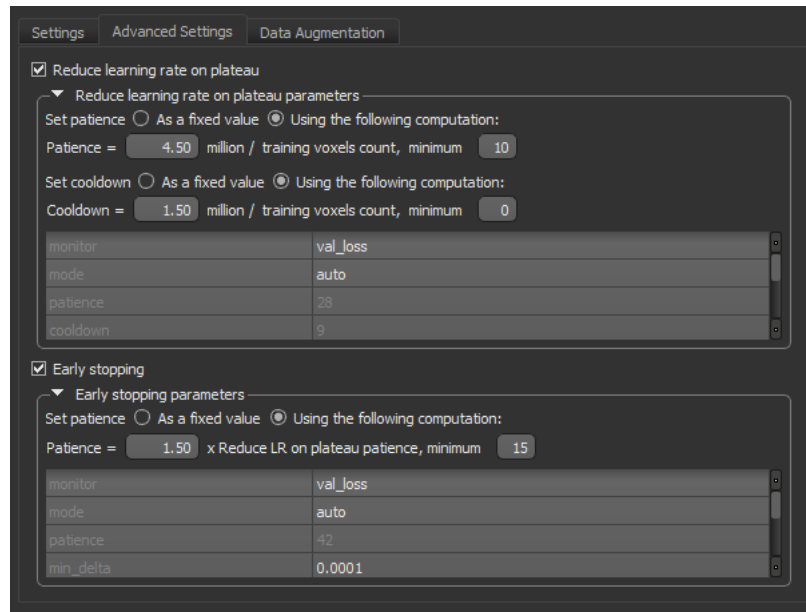

You should note the following whenever you edit the 'Reduce learning rate on plateau' and 'Early stopping' settings:

- Training voxels count will be shown as a tooltip whenever you hover over the **training voxel count** text, as shown below.

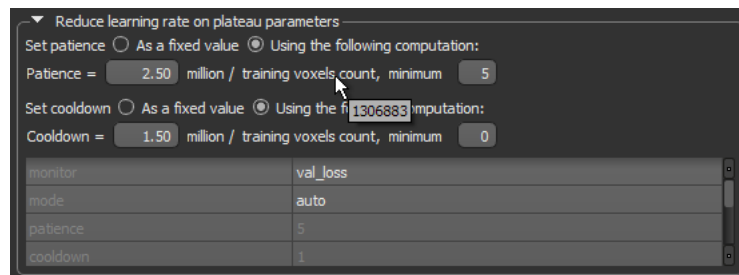

- With the **'As a fixed value'** option checked, the computation section will be disabled and the behavior will be "normal".
- With the **'Using the following computation'** option checked, the value in table will not be editable, but will be updated with the calculation result.



**Data Augmentation...** The options on the Data Augmentation tab, shown below, let you augment the amount of training data available and to select the different transformations that will be applied to simulate more data than is actually available.

Data Augmentation tab

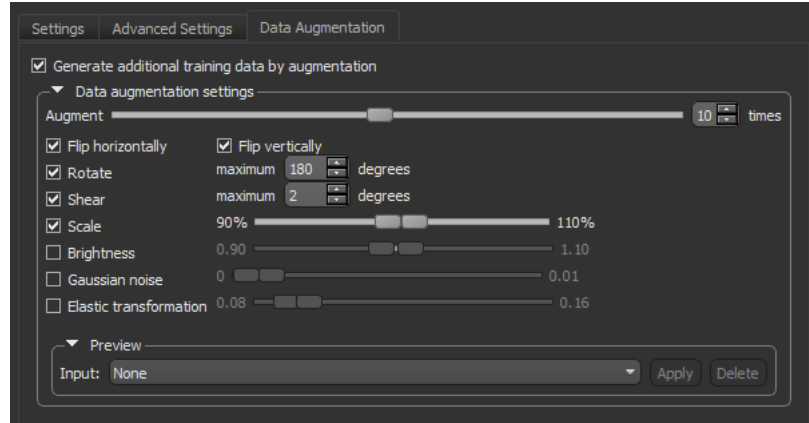



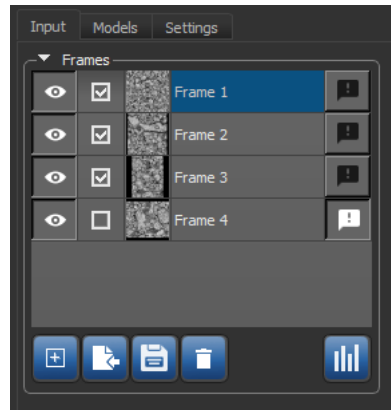

### Changes for Working with Frames

A number of interface changes were implemented for the **Input** tab, mainly a switch from textual buttons to icons, as well as the addition of the option to display frame statistics. This includes the total number of voxels and labeled voxels, as well as the number of voxels labeled for each class.

Frames panel



Options for frames

		Description
Add new frame		Adds a new frame to the current view.
Import frame(s) from a multi-ROI		Lets you import the frames from a multi-ROI that was exported from the Segmentation Wizard.
Export all frames as a single multi-ROI		Exports all frames as a multi-ROI. Exported frames will appear in the main context as a multi-ROI and will be exported in the same shaped as the loaded dataset(s).
Remove selected frame(s)		Removes the selected frame or frames. <b>NOTE</b> This item was previously available only for a single frame.

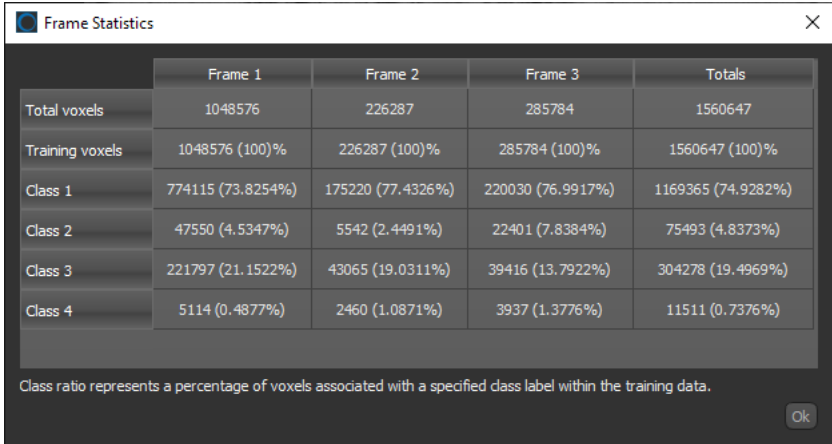
		Description																																			
Show statistics for all training frames		<p>Opens the Frame Statistics dialog, which is shown below.</p>  <table border="1" data-bbox="589 373 1399 651"> <thead> <tr> <th></th> <th>Frame 1</th> <th>Frame 2</th> <th>Frame 3</th> <th>Totals</th> </tr> </thead> <tbody> <tr> <td>Total voxels</td> <td>1048576</td> <td>226287</td> <td>285784</td> <td>1560647</td> </tr> <tr> <td>Training voxels</td> <td>1048576 (100)%</td> <td>226287 (100)%</td> <td>285784 (100)%</td> <td>1560647 (100)%</td> </tr> <tr> <td>Class 1</td> <td>774115 (73.8254%)</td> <td>175220 (77.4326%)</td> <td>220030 (76.9917%)</td> <td>1169365 (74.9282%)</td> </tr> <tr> <td>Class 2</td> <td>47550 (4.5347%)</td> <td>5542 (2.4491%)</td> <td>22401 (7.8384%)</td> <td>75493 (4.8373%)</td> </tr> <tr> <td>Class 3</td> <td>221797 (21.1522%)</td> <td>43065 (19.0311%)</td> <td>39416 (13.7922%)</td> <td>304278 (19.4969%)</td> </tr> <tr> <td>Class 4</td> <td>5114 (0.4877%)</td> <td>2460 (1.0871%)</td> <td>3937 (1.3776%)</td> <td>11511 (0.7376%)</td> </tr> </tbody> </table> <p>Class ratio represents a percentage of voxels associated with a specified class label within the training data.</p>		Frame 1	Frame 2	Frame 3	Totals	Total voxels	1048576	226287	285784	1560647	Training voxels	1048576 (100)%	226287 (100)%	285784 (100)%	1560647 (100)%	Class 1	774115 (73.8254%)	175220 (77.4326%)	220030 (76.9917%)	1169365 (74.9282%)	Class 2	47550 (4.5347%)	5542 (2.4491%)	22401 (7.8384%)	75493 (4.8373%)	Class 3	221797 (21.1522%)	43065 (19.0311%)	39416 (13.7922%)	304278 (19.4969%)	Class 4	5114 (0.4877%)	2460 (1.0871%)	3937 (1.3776%)	11511 (0.7376%)
	Frame 1	Frame 2	Frame 3	Totals																																	
Total voxels	1048576	226287	285784	1560647																																	
Training voxels	1048576 (100)%	226287 (100)%	285784 (100)%	1560647 (100)%																																	
Class 1	774115 (73.8254%)	175220 (77.4326%)	220030 (76.9917%)	1169365 (74.9282%)																																	
Class 2	47550 (4.5347%)	5542 (2.4491%)	22401 (7.8384%)	75493 (4.8373%)																																	
Class 3	221797 (21.1522%)	43065 (19.0311%)	39416 (13.7922%)	304278 (19.4969%)																																	
Class 4	5114 (0.4877%)	2460 (1.0871%)	3937 (1.3776%)	11511 (0.7376%)																																	
		<p>For each frame, the total number of voxels and training (labeled) voxels, as well as the number of voxels labeled for each class, is shown. In addition the percentage of voxels associated with each class label within the training data is indicated.</p>																																			

**NOTE** The previously available Fill button was deprecated for this software release. The Fill options are now available only in the contextual menu for a selected frame or frames.

In addition, a number of new options are available in the contextual menu whenever multiple frames are selected, as shown below.

Contextual items for frames

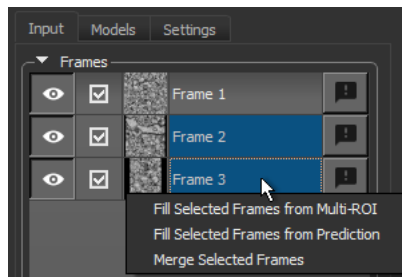

**Fill Selected Frames from Multi-ROI...** Lets you fill the selected frames from a multi-ROI. In this case, you can also choose to import the class names and colors.

**Fill Selected Frames from Prediction...** Lets you fill the selected frames from a prediction.

**Merge Selected Frames...** Lets you merge the selected frames into a new one. You should note that the frames must be on the same slice to enable this option.

Finally, a new option to create a copy of a frame is now available, as shown in the following screen capture. For example, in cases in which you may want to “split” a frame into two frames.

Duplicate frame

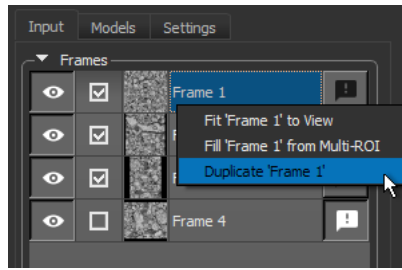

### Models Tab

The Models tab now includes a **Compute Score** option, circled below, that lets you update not available (NA) scores. For example, in cases in which training was stopped manually and the model score was not computed.

Models tab

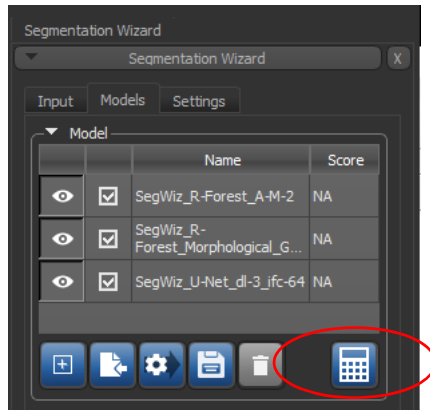

**Publishing models...** You should note that you need to 'publish' a model to make it available to other features of Dragonfly, such as **Segment with AI** and the **Deep Learning Tool**, for processing your data and other tasks. You can choose the models to publish and edit the default publish name in the Publish Models dialog, shown below.

Publish Models dialog



**Importing models...** You should note that when a model trained in Dragonfly's Deep Learning Tool is now imported into the Segmentation Wizard, only patch stride, data augmentation and callbacks will be updated. All other parameters will remain unchanged.

## Model Generation Strategies

A number of new model generation strategies are now available in the Model Generation Strategy dialog, shown below. The Model Generation Strategy dialog appears automatically when you click **Train** for the first time. It can also be opened by clicking the **Model Generation Strategy** button on the Models tab.

Model Generation Strategy dialog

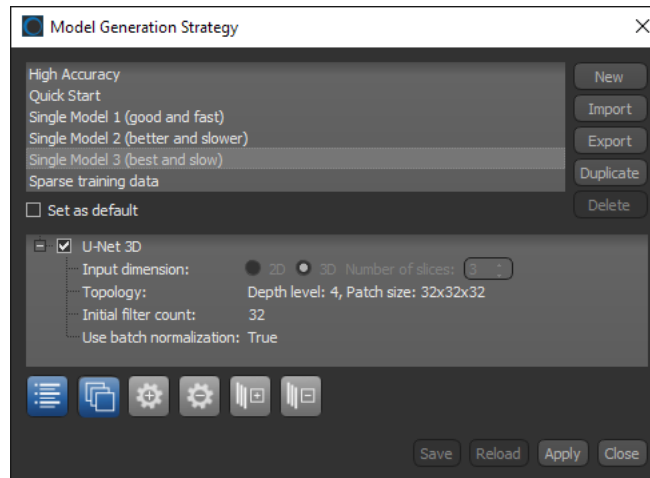

**Single Model 1 (good and fast)...** This new strategy includes U-Net with a 2D input dimension, a depth level of 5, and an initial filter count of 64.

**Single Model 2 (better and slower)...** This new strategy includes U-Net 3D with an input dimension of 3 slices, a depth level of 5, and an initial filter count of 64.

**Single Model 3 (best and slow)...** This new strategy includes U-Net with a 3D input dimension of 3 slices, a depth level of 4, patch size of 32x32x32, an initial filter count of 32, and uses batch normalization.

**Sparse Training Data...** This new strategy, which can be used when only sparse labeling is available, includes the two random forest models available in the Quick Start model generation strategy.

## Deep Learning Tool

Updates for Dragonfly’s Deep Learning Tool include the option to visually monitor the progress of training and to save a copy of a model at a selected checkpoint.

**NOTE** Support for Tensor Board, which provided the option to display various statistics in a browser while training, is longer available as of version 2021.3. You should also note that this callback was disabled by default in previous versions.

## Monitoring Model Training

To help monitor and evaluate the progress of training deep models for semantic segmentation and regression tasks, you can designate a 2D rectangular region for visual feedback (see [Setting Regions for Visual Feedback](#) on page 22). With the Visual feedback option selected, the model’s inference within the region will be displayed in the Model Training dialog in real time as each epoch is completed, as shown below. In addition, you can create a checkpoint cache so that you can save a copy of the model at a selected checkpoint (see [Enabling Checkpoint Caches](#) on page 23 and [Loading and Saving Model Checkpoints](#) on page 23). Saved checkpoints are marked in bold on the plotted graph.

Training Model dialog

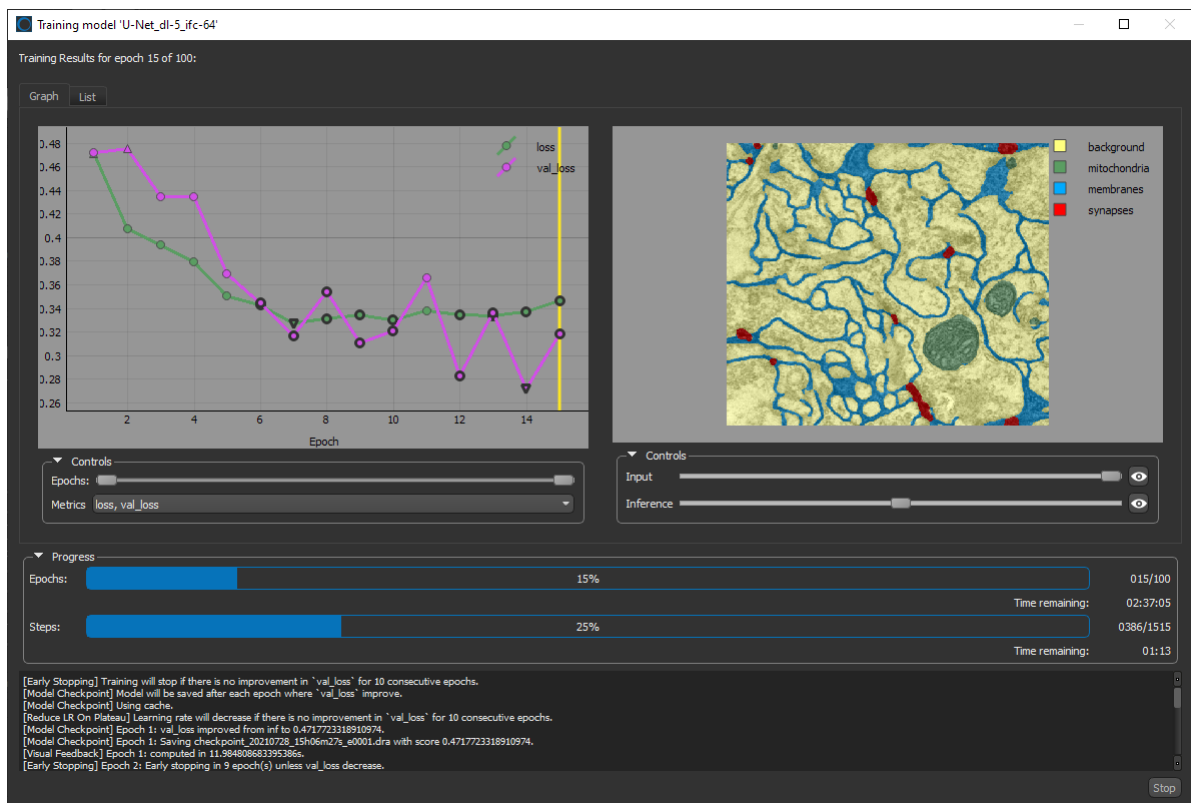

TM021-A-10

### Setting Regions for Visual Feedback

You can designate a 2D rectangular region for visual feedback to help monitor and evaluate the progress of models for semantic segmentation and regression tasks. Do the following to set a region for visual feedback:

1. Scroll to a representative slice within your input dataset.
2. With the **Rectangle** tool that is available on the Annotate panel, add a 2D rectangular region that includes the area or features you want to monitor during training.

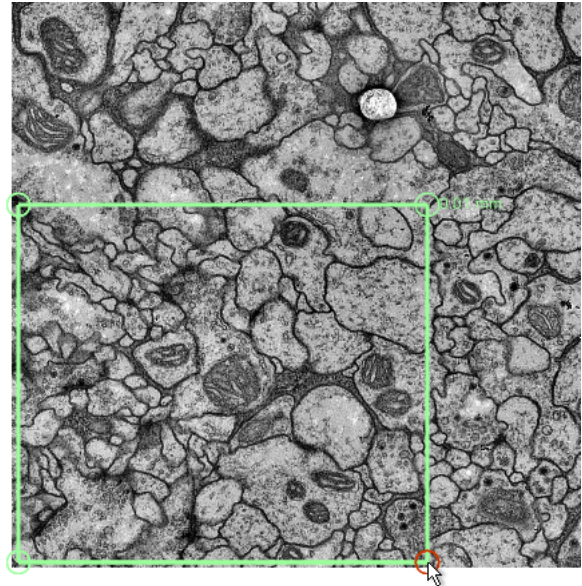
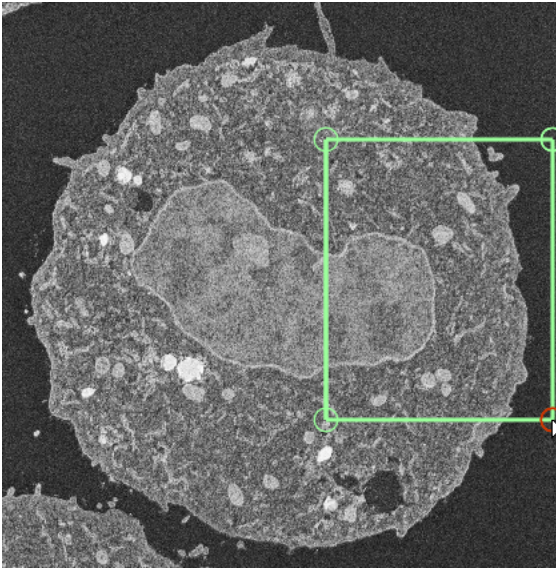

**NOTE** Any region that you define for visual feedback should not overlap with your training data.

3. Choose the required region in the **Visual feedback** drop-down menu on the Inputs tab when you set the training inputs.

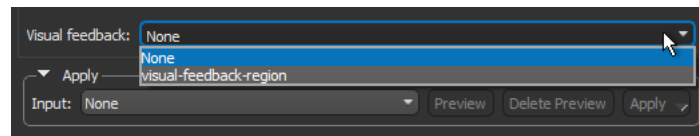

**NOTE** The visual feedback image for each epoch is saved when model training is complete. You can review the result of each epoch by scrolling through the plotted graph. If the checkpoint cache is enabled, you can also save the model at a selected checkpoint when you review the training results (see [Loading and Saving Model Checkpoints](#) on page 23).

## Enabling Checkpoint Caches

A new set of preferences are available in Dragonfly 2021.3 to enable the checkpoint cache option and to set the size limits for the cache. Go to **Preferences > Deep Learning** to open these new preferences, shown below.

Deep Learning preferences

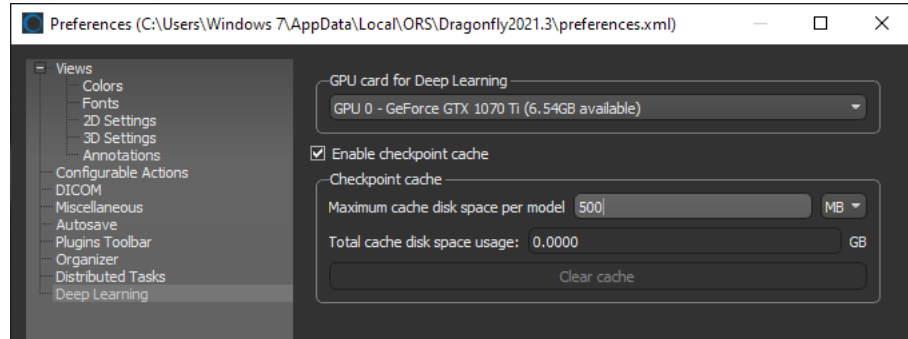

**Enable checkpoint cache...** Check this item to enable the checkpoint cache.

**Maximum cache disk space per model...** Lets you set the per model limit for the cache disk space. You should note that models will be saved at a checkpoint each time that it has a better score until the cache limit is reached. Afterwards, the model with the lowest score will be cleared so that the new checkpoint can be saved.

**Total cache disk space usage...** Indicates the total size of the checkpoint cache. If required, you can clear the checkpoint cache by clicking **Clear cache**.

## Loading and Saving Model Checkpoints

You can load and then save a model at a selected checkpoint by loading and displaying the model's training results. Right-click your trained model and then choose the required training results in the **Display Training History** submenu to open the Training dialog, shown in the following screen capture.

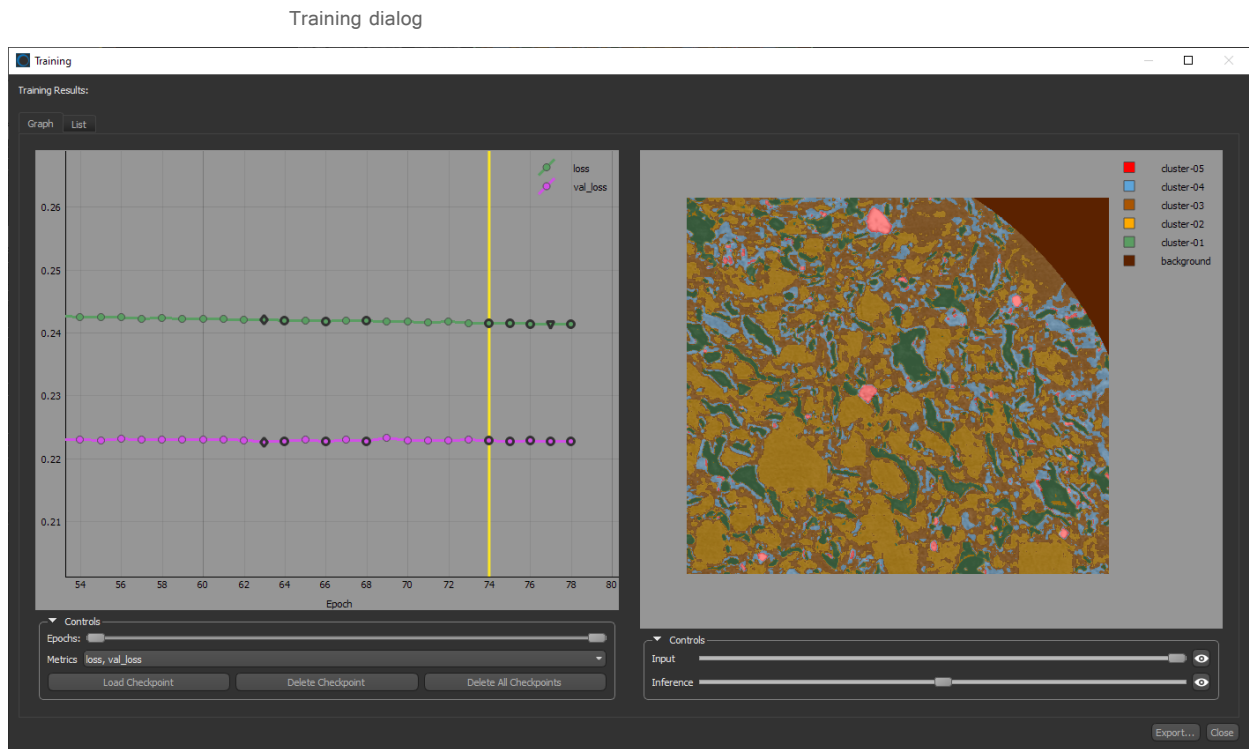

In the Training Results dialog you can:

- Scroll through the graph to visually evaluate the inference at different checkpoints.
- Select additional metrics to plot.
- Load a selected checkpoint by clicking **Load Checkpoint**. You can then save a copy of the model at the loaded checkpoint.



## Filter with AI

The new **Filter with AI** feature lets you apply deep models trained for regression tasks, such as denoising and super resolution, directly to your image data.

Choose **Artificial Intelligence > Filter with AI** on the menu bar or right-click the dataset you want to process on the Data Properties and Settings panel and then choose **Filter with AI** in the pop-up menu to open the panel to open the dialog shown below.

Filter with AI dialog

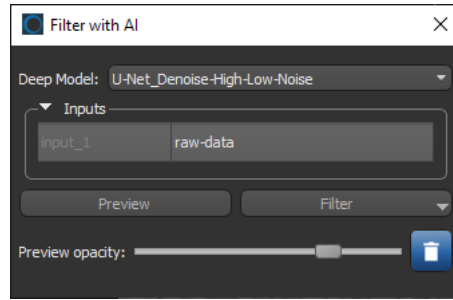

**NOTE** By default, the Filter with AI panel is available on the Main tab and can be floated, if required.

The following options are available on the Filter with AI panel.

Filter with AI options

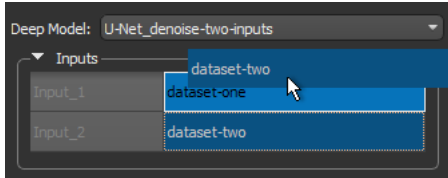
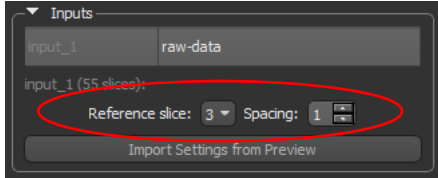
	Description
Deep Model	Lets you choose a deep model trained for regression tasks. You should note that models are filtered based on the current number of datasets selected.
Inputs	<p>Indicates the currently selected input(s).</p> <ul style="list-style-type: none"> <li>To change the selection, choose another item(s) in the Data Properties and Setting panel.</li> <li>For multi-input models, you change the order of the selected inputs by dragging an input, as shown below.</li> </ul>  <p><b>NOTE</b> Input order must be consistent with model training.</p> <ul style="list-style-type: none"> <li>For 3D models, you can modify the default Reference slice and Spacing setting, if required.</li> </ul>  <p><b>Import Settings from Preview...</b> Lets you import the settings from a selected 3D model preview. Previews can be selected in the <b>Chose a Preview to Import Settings</b> dialog.</p>

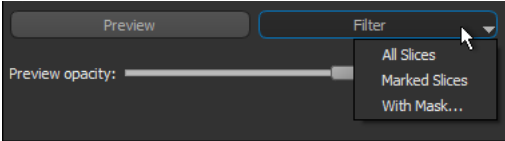
	Description
Preview	<p>Lets you generate previews using the currently selected regression model. You should note that previews are limited to the visible voxels in the selected 2D view.</p> <p>The following options are available for filter previews:</p> <ul style="list-style-type: none"> <li>You can choose different settings for the input(s). For example, input order for multi-modality models and reference slice and spacing for 3D models.</li> <li>The opacity of the preview can be adjusted with the <b>Preview opacity</b> slider.</li> </ul>
Filter	<p>Lets you choose how filtering will be applied, as shown below. The resulting filtered dataset will added to the Data Properties and Settings panel when processing is complete.</p>  <p><b>All slices...</b> If selected, the full dataset will be processed.</p> <p><b>Marked slices...</b> If selected, only marked slices will be processed.</p> <p><b>With mask...</b> If selected, only data within the region of interest selected as the mask will be processed.</p>

## Machine Learning Segmentation

You should note that the option to preview results for Machine Learning (Classical) models is now available at the bottom of the Machine Learning Segmentation dialog from all tabs.

Preview options

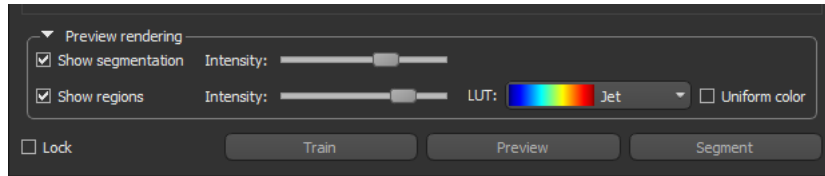

## Segment with AI

The following update is available of the Segment with AI feature, which lets you automatically segment datasets with any of the deep learning or machine learning models that you trained, imported, or downloaded.

In this software release, you can reorder your initial selection by dragging an input in the **Inputs** box in the Segment with AI panel, as shown below.

Reordering of image modalities

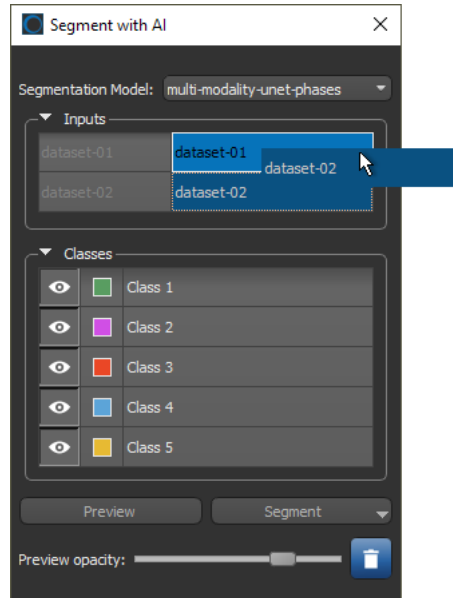

**NOTE** For multi-modality models, the order of the inputs for inference must be consistent with the model training.

## Intensity Scale Calibrations

This software release provides the option to calibrate the intensity scale of multiple images to a set of calibration standards. By setting-up a standard calibration, the intensity values of different materials or tissue will be consistent, regardless of the sample acquired.

The calibration procedure is done in three steps:

1. Create a set of calibration standards in the Dimension Unit Manager (see [Creating Calibration Standards](#) on page 29).
2. Right-click the data you need to calibrate and then choose **Calibrate Intensity Scale** in the pop-up menu. To calibrate an image, first select the appropriate calibration standard in the Intensity Calibration dialog. You can then enter the raw intensity values measured on the data you need to calibrate that correspond to the labels of your standard.

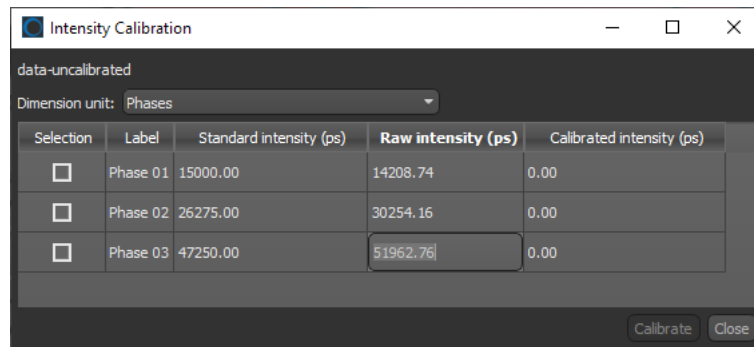

**NOTE** You can use the **Probe** tool to find the intensity values of different materials or tissue in a dataset.

3. Choose the two selections that will provide the values for fitting. You can then click the **Calibrate** button to calibrate the image.

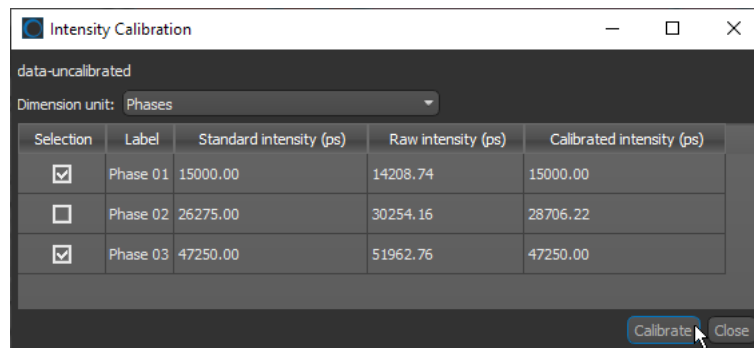

**NOTE** If the calibration function is not satisfactory, you can change your selections and then evaluate the re-calibrated intensity.

## Dimension Unit Manager

This new utility for Dragonfly 2021.3 lets you create new units, as well as calibration standards for intensity scale calibrations. Choose **Utilities > Dimension Unit Manager** to open the Dimension Unit Manager dialog, shown below.

Dimension Unit Manager dialog

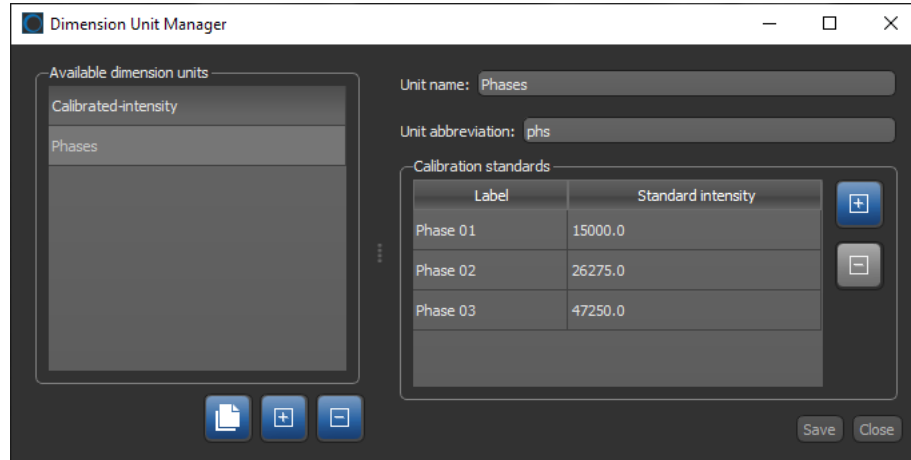

### Creating New Dimension Units

You can create new dimension units for either assigning to image data or for performing intensity-scale calibrations.

Do the following to create a new dimension unit:

1. Choose **Utilities > Dimension Unit Manager** to open the Dimension Unit Manager dialog.
2. Click the '+' button on the bottom left to create a new unit.
3. Enter a name for the new unit and a unit abbreviation in the appropriate fields.
4. Click **Save** to save your new dimension unit.

### Creating Calibration Standards

For intensity-scale calibrations, you will need to first create a dimension unit with standard intensities for each phase or tissue type.

Do the following to create a calibration standard:

1. Create a new dimension unit in the Dimension Unit Manager dialog, if required (see [Creating New Dimension Units](#) on page 29).
2. Add the required labels in the Calibration standards box and their associated standard intensities.
 

**NOTE** You can use the **Probe** tool to find the intensity values of different materials or tissue in a dataset.
3. Click **Save**.

**NOTE** Refer to the topic [Intensity Scale Calibrations](#) on page 28 for information about calibrating your image data.

## Image Properties (Dimension Units)

The option to assign dimension (physical) units to a dataset is available in this software release. For example, to images created from multi-ROIs with scalar values (see [Creating Images from Scalars](#) on page 57). To assign a unit to your data, right-click the required object in the Data Properties and Settings panel and then choose **Image Properties** in the pop-up menu. Units are available in the drop-down menu on the Image Properties panel, as shown below.

Image Properties panel

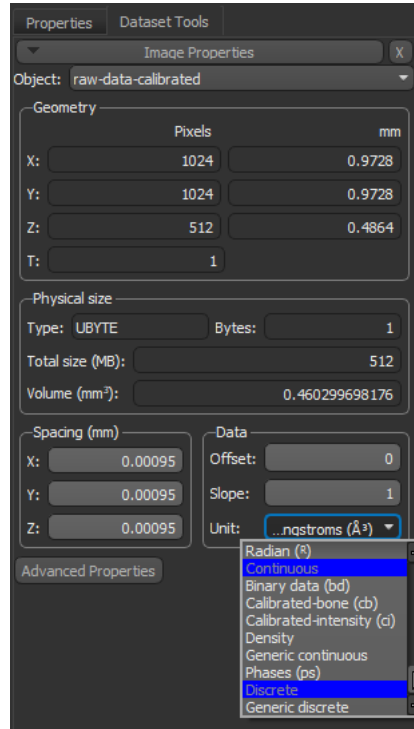

This enhancement also includes better coherence when changing the units used in scene views. For example, in cases in which the units of a distance map are converted through the **Change Unit** options on the Scene's Views Properties panel. You should also note that for CSV exports, units will be converted to the selected scene view units.

---

**NOTE** Specifying a dimension unit is not a calibration, it is just an assignment. See [Spatial Scale Calibrations](#) on page 31 for information about spatial scale calibrations.

---

**NOTE** You can create your own units in the Dimension Unit Manager. See [Creating New Dimension Units](#) on page 29 for information about this new feature for Dragonfly.

---

## Spatial Scale Calibrations

You can now calibrate the spatial scale of images, regions of interest, and multi-ROIs so that measurement results are presented with the correct values. To perform a spatial scale calibration, you first need to use the Ruler tool to make a line selection that corresponds to a known distance.

**NOTE** Calibrating an object will modify its current dimensions, making existing measurements obsolete.

### How to Perform a Spatial Scale Calibration

1. Open the image, region of interest, or multi-ROI that you need to calibrate.
2. Zoom-in on a fiducial marker or object of known dimensions in a 2D or 3D view, recommended.

**NOTE** You can remove image interpolation to better view the edges of the marker or object in 2D views. To do so, choose **Interpolation > Nearest** in the 2D settings box on the Data Properties and Settings panel.

3. Select the **Ruler** tool and then draw a line that is exactly the same length as the marker or object.
4. Right-click the object you need to calibrate in the Data Properties and Settings panel and then choose **Calibrate Spatial Scale** in the pop-up menu.
5. Choose the ruler you used to make the measurement in the Choose the Ruler to Calibrate With dialog and then click **OK**.

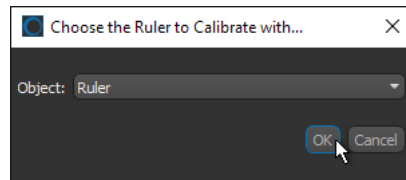

6. Enter the known length of the ruler in the Expected Length of Chosen Ruler dialog and then click **OK**.

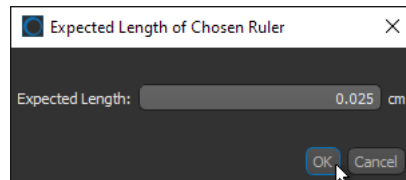

Spacing is updated automatically.

## Scalar Generator

With the new Scalar Generator for Dragonfly 2021.3, you can add measurements and values to the classes within a multi-ROI, as well as to meshes, graphs, and vector fields.

Right-click the object to which you want add scalar values and then choose **Scalar Generator** in the pop-up menu to open the Scalar Generator dialog, shown below.

Scalar Generator dialog

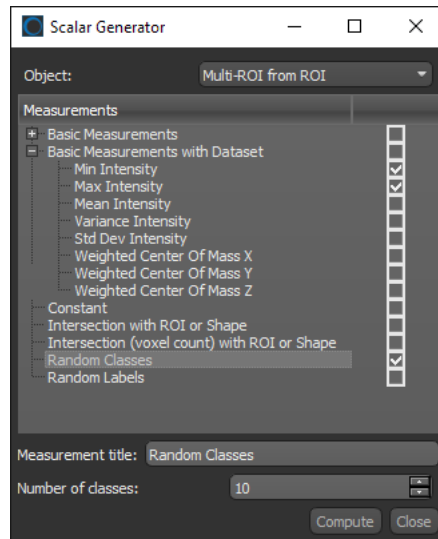

### Scalar Values for Multi-ROIs

The following measurements and values can be added to multi-ROIs in the Scalar Generator dialog.

Measurements and scalar values for multi-ROIs

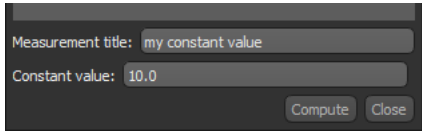
	Description
Basic Measurements	Lets you compute values, such as volumes, surface areas, Phi and Theta angles, aspect ratios, or the centers of mass, corresponding to the classes within the selected multi-ROI. <b>NOTE</b> Descriptions of these parameters are available in the Dragonfly Help system in the topic <b>Statistical Properties</b> , which you can find in <b>Specialized Workflows &gt; Connected Components Analysis</b> .
Basic Measurements with Dataset	Lets you compute values, such as minimum, mean, maximum intensity values, weighted centers of mass, and entropy, corresponding to image data and the classes within the selected multi-ROI. <b>NOTE</b> Descriptions of these parameters are available in the Dragonfly Help system in the topic <b>Statistical Properties</b> , which you can find in <b>Specialized Workflows &gt; Connected Components Analysis</b> .
Constant	Lets you add a constant value to each class within the selected multi-ROI. You can choose a measurement title and value for the constant, as shown below. 

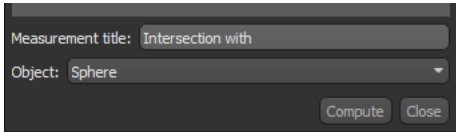
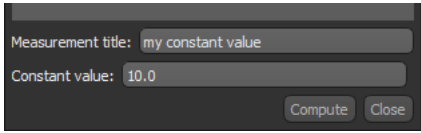

	Description
Intersection with ROI or Shape	Lets you identify classes that intersect with a region of interest or a shape, such as a box, capsule, cylinder, or sphere. You can enter a title for the measurement and choose the intersecting object. 
Intersection (voxel count) with ROI or Shape	Lets you find compute the number of voxels in classes that intersect with a region of interest or a shape, such as a box, capsule, cylinder, or sphere. You can enter a title for the measurement and choose the intersecting object.
Random Classes	Adds the specified number of classes to the selected multi-ROI. You can enter a title for the values and choose the number of classes, as shown below.  <p><b>NOTE</b> The maximum number of random classes you can add is equal to the current number of classes.</p>
Random Labels	Adds random labels to the selected multi-ROI.

Computed measurements and scalar values will be available in the Scalar information box. The values for each class can be viewed in the **Classes and scalar information** box, as shown below.

Classes and scalar information box

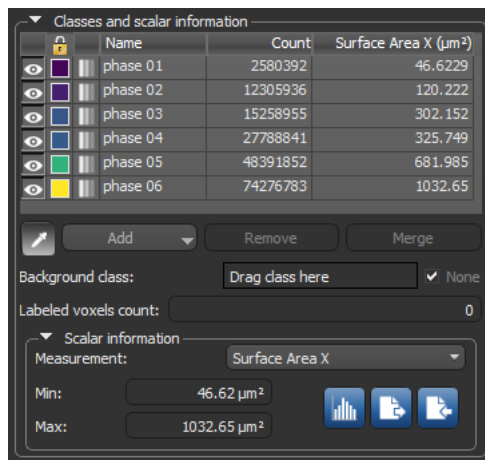

## Measurements and Scalar Values for Meshes

The following measurements and scalar values can be added to or computed for meshes in the Scalar Generator dialog.

Scalar Generator dialog

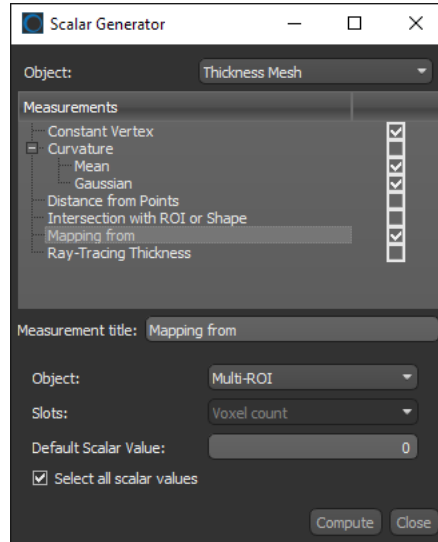

Measurements and scalar values for meshes

	Description
Constant Vertex	Adds a constant vertex value. You can enter a title for the measurement and choose the constant value.
Curvature	Adds curvature measurements computed with the <b>Mean</b> and/or <b>Gaussian</b> method.
Distance from Points	Adds distance measurements computed from the mean position of a series of points. <b>NOTE</b> You must first create a points set with the <b>Points tool</b> to enable this option.
Intersection with ROI or Shape	Lets you identify mesh edges that intersect with a region of interest or a shape, such as a box, capsule, cylinder, or sphere. You can enter a title for the measurement and choose the object to intersect with.
Mapping From	Lets you map the scalar values from another object, such as an image, multi-ROI, or scalar mesh. You can enter a title for the measurement, as well as chose the object to map from and a default scalar value. <b>NOTE</b> Mapping from meshes is done with by closest face matching, while mapping from images and multi-ROIs is done through corresponding world coordinates. For best results, the number of distinct objects in the selected mesh and multi-ROI should be equivalent.
Ray-Tracing Thickness	Adds thickness values computed with the normal ray-tracing method (see <a href="#">Thickness Analyses</a> on page 59).

## Measurements and Scalar Values for Graphs

The following measurements and scalar values can be added to graphs in the Scalar Generator dialog.

Scalar Generator dialog

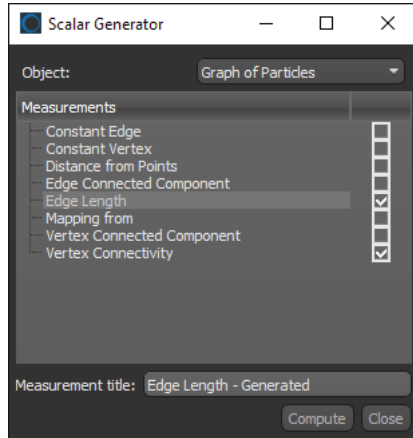

Measurements and scalar values for graphs

	Description
Constant Edge	Adds a constant edge measurement to the selected graph. You can enter a title for the measurement and choose the constant value.
Constant Vertex	Adds a constant vertex measurement to the selected graph. You can enter a title for the measurement and choose the constant value.
Distance from Points	Adds scalar values of measured distances from the mean position of a series of points. You can enter a title for the measurement, as well as choose the required Points series. <b>NOTE</b> You must first create a points set with the Points tool to enable this option
Edge Connected Component	Adds edge connected components measurements, which is a representation of the labelization of the graph. You can enter a title for the measurement.
Edge Length	Adds measurements equal to the length of the line connecting two branches or a brand and end node. You can enter a title for the measurement.
Mapping From	Lets you map the scalar values from another object, such as an image, multi-ROI, or scalar mesh, to the selected graph. You can enter a title for the measurement, as well as chose the object to map from and a default scalar value.
Vertex Connected Component	Adds vertex connected components measurements, which is a representation of the labelization of the graph. You can enter a title for the measurement.
Vertex Connectivity	Adds measurements of connectivity, which is defined as the number of vertices (or edges) that are connected to a vertex. You can enter a title for the measurement.

### Scalar Values for Vector Fields

The following scalar values can be added to graphs in the Scalar Generator dialog.

Scalar Generator dialog

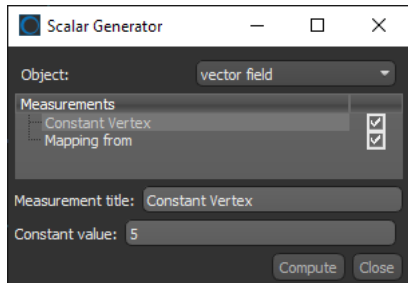

Scalar values for vector fields

	Description
Constant Vertex	Adds a constant vertex measurement to the selected vector field. You can enter a title for the measurement and choose the constant value.
Mapping From	Lets you map the scalar values from another object, such as an image, multi-ROI, or scalar mesh, to the selected vector field.

## Annotations

A number of new properties and settings are available for annotations, such as rulers, arrows, points series, and scale bars, in this software release.

### Ruler Properties

This software release introduces the concept of 'projected rulers' for 2D and 3D views. As shown in the following screen capture, a projected ruler includes two lines that extend from the start and end points of the annotation with an arrow that connects the two lines and the measurement or custom caption.

Projected rulers in 3D view

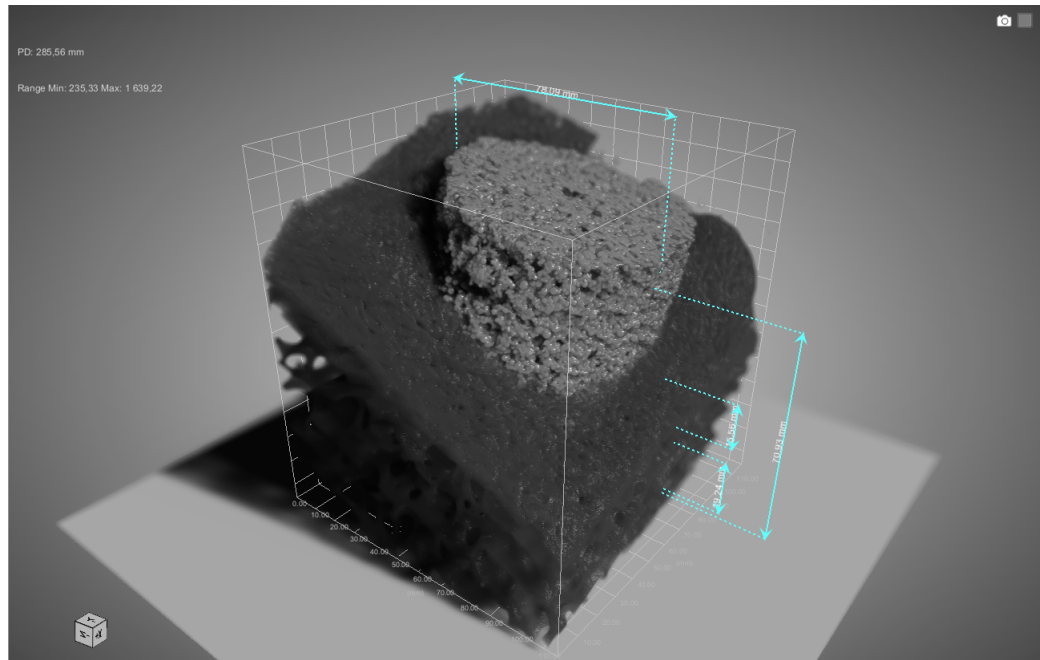

A number of new settings are also available in the Properties box, as shown in the following screen capture, for customizing the appearance of rulers in 2D and 3D views.

Ruler properties

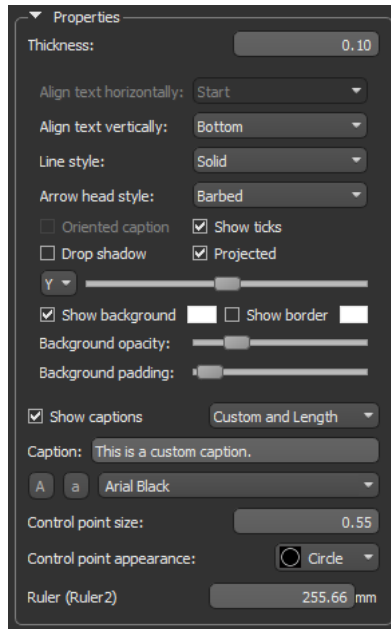

The following settings are available for rulers in Dragonfly 2021.3.

Ruler properties

	Description
Thickness	Indicates the thickness (in screen percentage) of the annotation. <ul style="list-style-type: none"> <li>Enter a new number in the edit box to change the thickness of the selected ruler.</li> </ul>
Align text horizontally	Lets you align text in 2D views horizontally — either at Start, Center, or at the End of the annotation.
Align text vertically	Lets you align text in 2D views vertically — either at the Top of Bottom of the annotation.
Line style	Lets you choose a line style — either Solid or Dashed — that will be applied to the annotation in 2D views.
Arrow head style	Lets you choose the style — None, Flat, or Barbed — of the arrow heads applied to the ruler.
Oriented caption	If selected, length captions will be aligned along the ruler in 2D views. <b>NOTE</b> Not available for rulers shown in projected mode.
Show ticks	If selected, shows tick marks indicating the start and end points of the ruler in 2D views.
Drop shadow	If selected, adds a drop shadow to the annotation in 2D views.
Projected	If selected, rulers will be shown in projected mode. In this case, you can choose the orientation of the projection in the drop-down menu, as well as adjust the distance from the ruler with the slider.
Background	Lets you apply a stylized background to a ruler in 2D views as follows: <b>Show background...</b> If checked, a solid background will appear in the 2D view of the annotation. You can choose a color by clicking the color swatch. <b>Show border...</b> If checked, a border will appear around the background in the 2D view of the annotation. You can choose a color by clicking the color swatch. <b>Background opacity...</b> This slider lets you adjust the opacity of the background, from 0% to 100%. <b>Background padding...</b> This slider lets you adjust the size of the background.

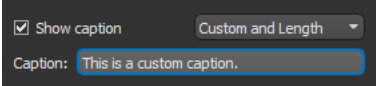
	Description
Show captions	<p>If selected, a caption will be shown with the annotation.</p> <p><b>Length...</b> When selected, the length of the ruler will be shown.</p> <p><b>Custom...</b> When selected, the text entered in the Caption edit box will be shown.</p>  <p><b>Custom and Length...</b> When selected, the length of the ruler, as well as the text entered in the Caption edit box, will be shown.</p> <p><b>NOTE</b> You can choose a font for captions in the drop-down menu.</p>
Control point size	<p>Indicates the size (in screen percentage) of the annotation's control points.</p> <ul style="list-style-type: none"> <li>Enter a new number in the edit box to change the size of the control points.</li> </ul>
Control point appearance	<p>Lets you choose a shape — Circle, Square, Triangle, Cross, or 'X' — for the annotation's control points.</p> <ul style="list-style-type: none"> <li>Choose a shape in the drop-down menu to change th representation of the control points.</li> </ul>
Ruler	<p>Is the linear distance defined by the annotation on the image, in units according to the current measurement scale.</p> <ul style="list-style-type: none"> <li>Enter a new value in the edit box to change the length of the annotation. You can also resize rulers by dragging a control point.</li> </ul>

**Preferences for rulers...** The new ruler properties can also be set as preferences. Choose **Preferences > Views > Annotations** in the Preferences dialog to review and set the ruler preferences.

Ruler preferences

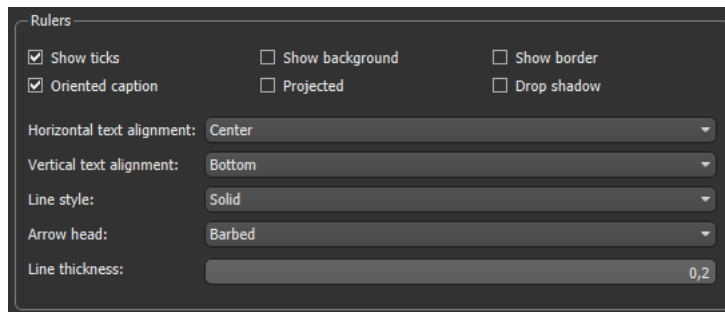

## Arrow Properties

In addition to being able to create and manipulate arrows in 3D views, a number of additional properties are also available for customizing the appearance of arrows and arrow captions.

Arrows in 3D view

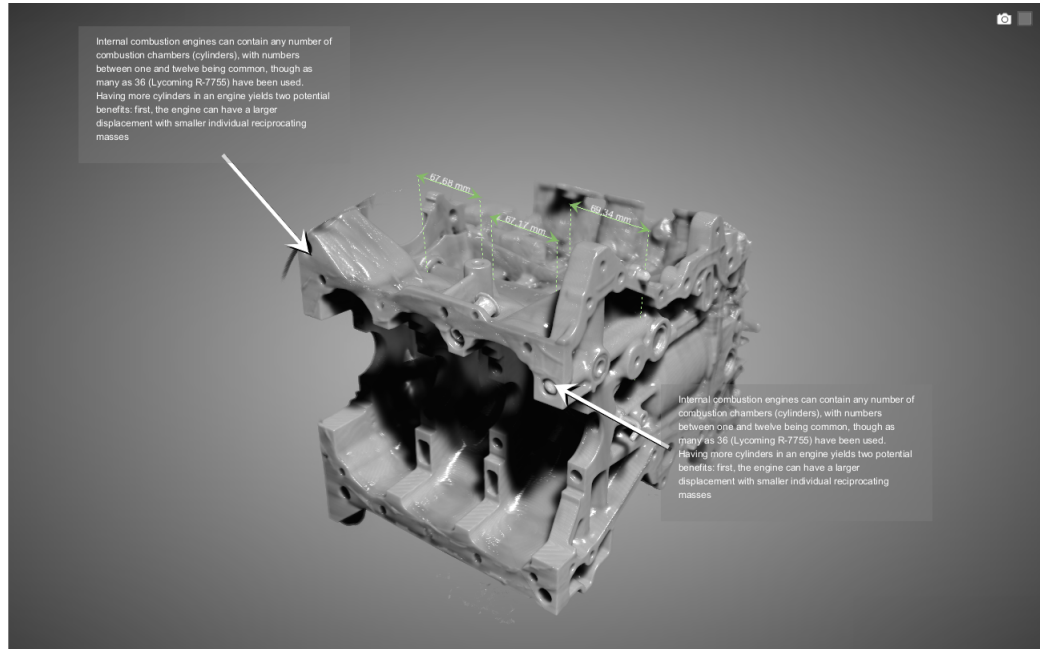

A number of new properties are available for selected arrows in the Data Properties and Settings panel, as shown below.

Arrow properties

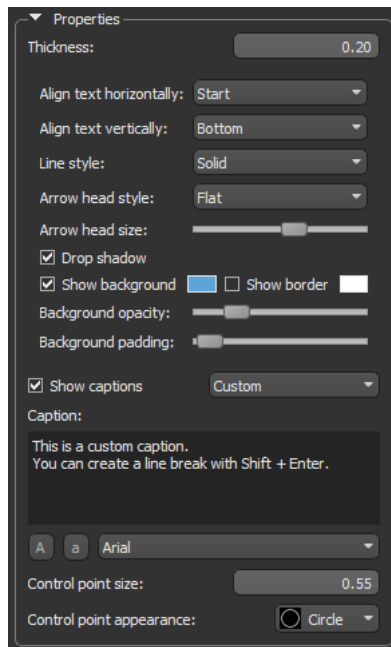



**NOTE** Arrow 3D properties — Fixed size — was removed for this software release. It is now possible, and more convenient, to adjust arrows directly in the 3D view.

**Preferences for arrows...** The new arrow properties can also be set as preferences. Choose **Preferences > Views > Annotations** in the Preferences dialog to review and set the arrow preferences.

Arrow preferences



### Scale Bar Properties

The appearance and orientation of scale bars in 2D views and orthographic 3D views can be customized through a contextual menu and set in preferences.

Customized scale bar in an orthographic 3D view

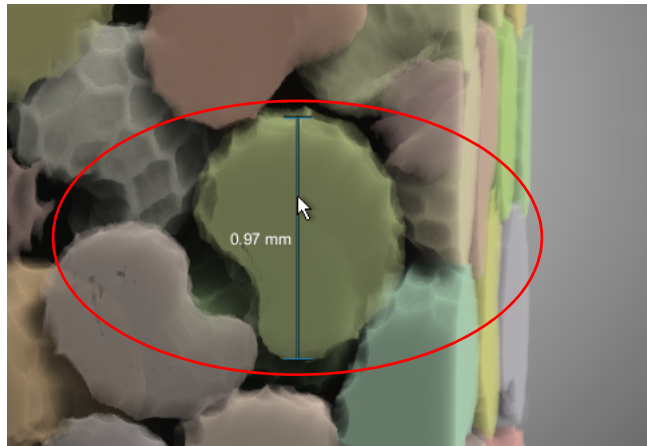

Right-click a scale bar to access the contextual menu, as shown below.

Pop-up menu for scale bars

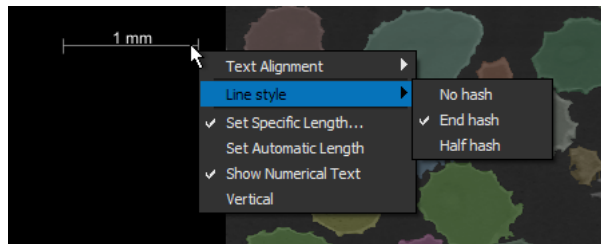

Scale bar menu items

	Description
Text Alignment	Lets you choose how text is aligned. Text can be aligned left, center, or right horizontally, as well as vertically on the top or bottom of the scale bar.
Line Style	Lets you choose a line style that has no hash marks, end hash marks, or half hash marks.

	Description
Set Specific Length	Lets you choose a specific length for the scale bar.
Set Automatic Length	Sets the length of the scale bar that automatically adjusts to the size of the view.
Show Numerical Text	If selected, shows the length of the scale bar.
Vertical	If selected, aligns the scale bar vertically.
Show Background	If selected, a semi-transparent background will be added to the scale bar.
Outline	If selected, an outline will be added to the scale bar.

**Preferences for scale bars...** The new options for scale bars can also be set as the defaults. Choose **Preferences > Views > Annotations** in the Preferences dialog to review and set the Scale bar preferences.

Scale bar preferences

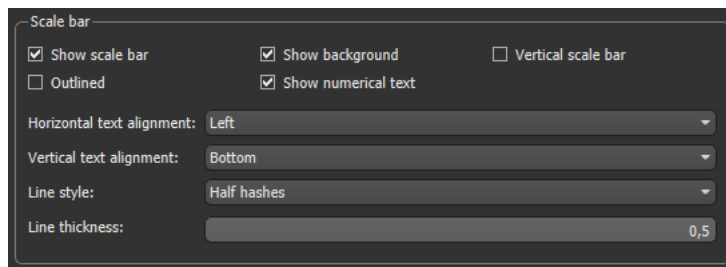

## Histogram Analysis

Histogram Analysis now features more options for extracting scalar values and measurements within regions of interest and shapes or along rulers, and also includes selectable bin counts, which can be important in cases in which large or small bins can lead to misleading results. As shown below, increasing the bin count when reviewing data with a Gaussian distribution results in a smoother curve without the pronounced spikes seen at smaller bins.

Limited bin count vs. more bins

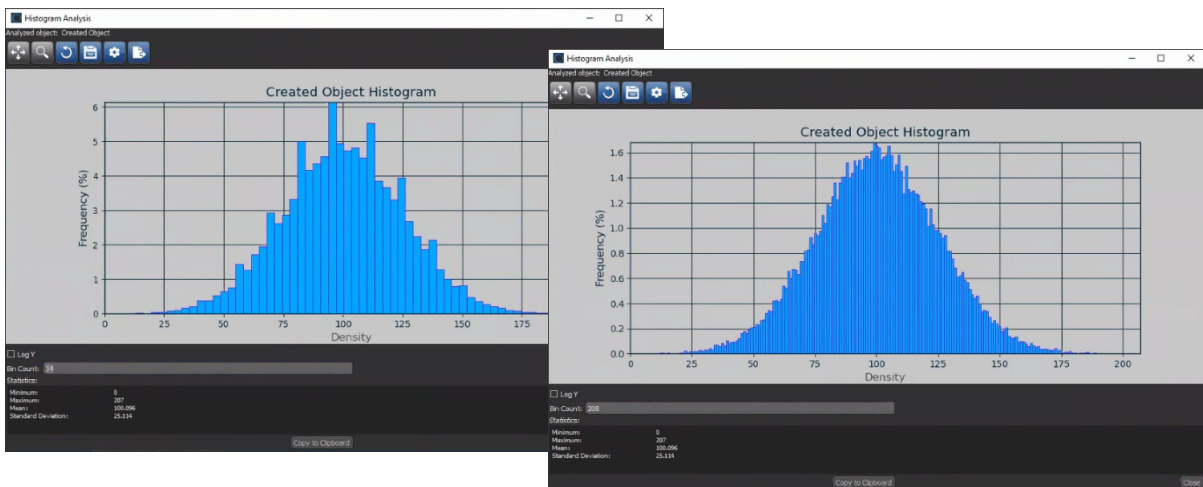

Other updates include automatic refreshes in real-time as adjustments are made to regions of interest, shapes, and rulers.

## MC X-Ray

A number of updates are available for Dragonfly's MC X-Ray module, which can simulate electron scattering in materials in order to correlate X-Ray emission to composition in quantitative X-ray microanalysis. Choose **Workflows > MC X-Ray Simulator** to open the MC X-Ray dialog.

### Simulation Results

MC X-Ray's simulation results were updated with plots for spectrum detected and electrons detected as shown in the following screen captures. Additional updates include an element line selector for computing X-ray intensities and an export to CSV option.

Plots for electrons detected (bottom left) and spectrum detected (top right)

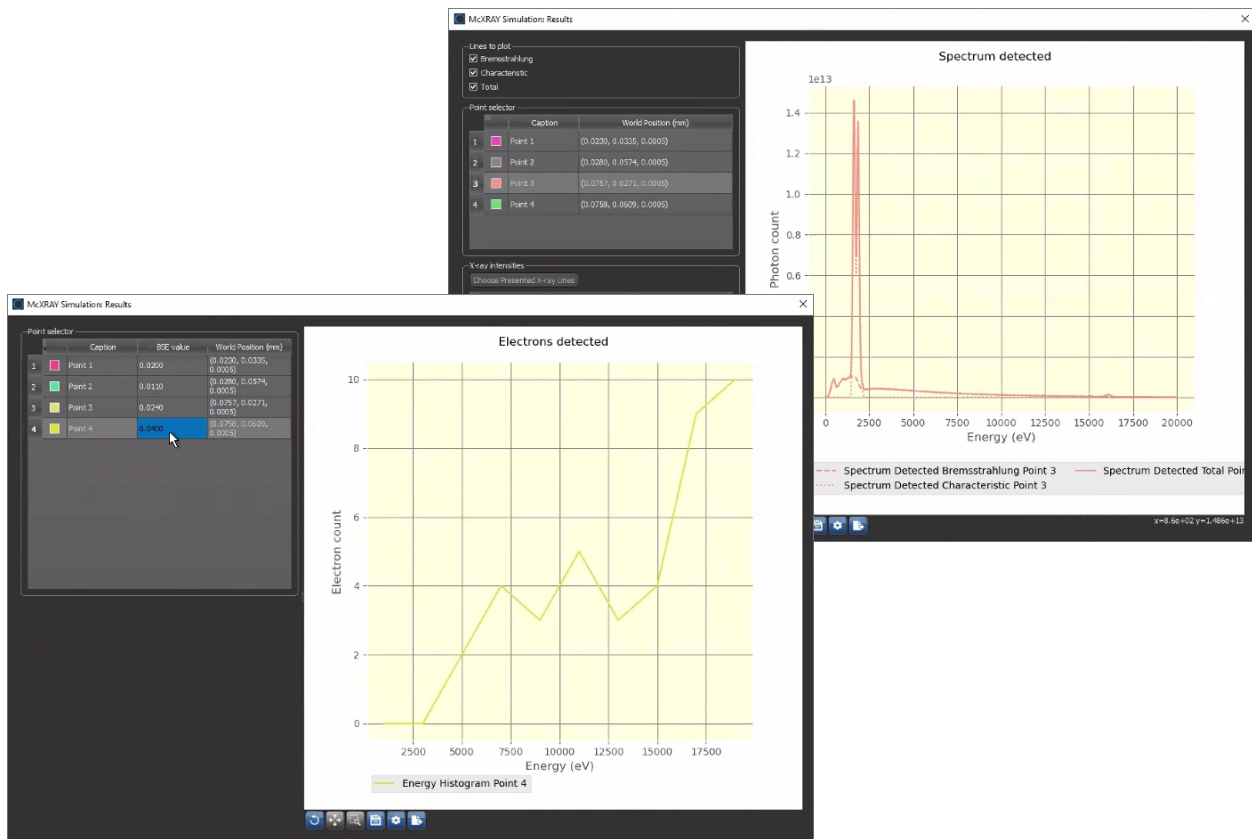

You can also choose to compute X-ray intensities for selected elements. Click the **Choose Presented X-ray Lines** button in the X-ray intensities box to open the Element Line Selector dialog, which is shown in the following screen capture.

Element Line Selector dialog

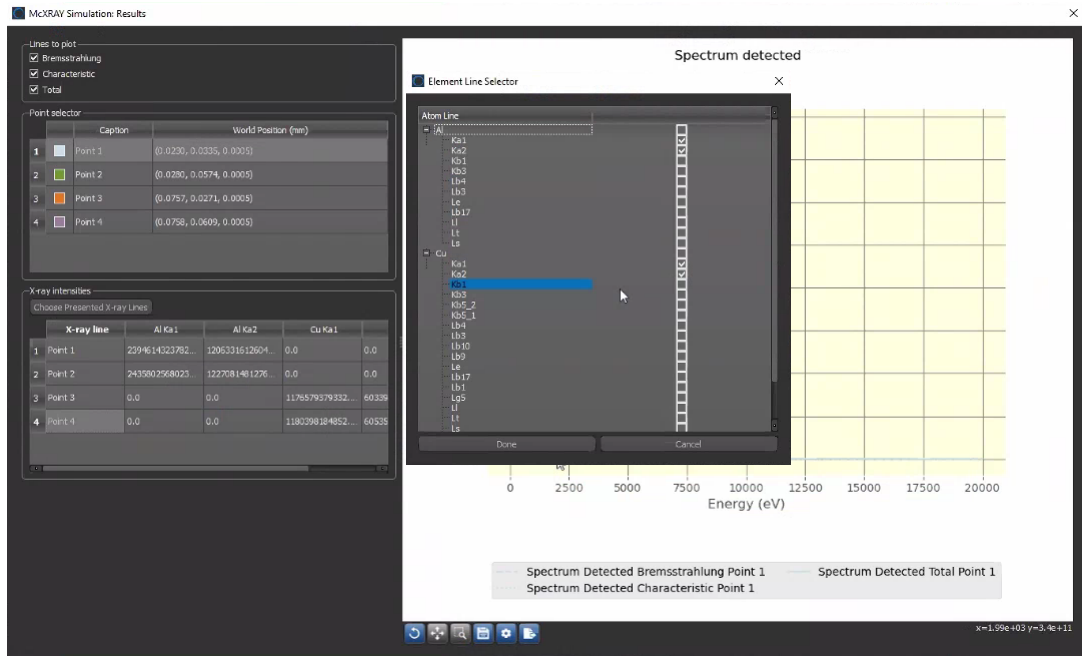

**Export results in CSV...** For electron detector simulation results, you can export the X-Y-Z coordinates and BSE ratio for each point in the CSV file format, while for X-ray detector simulation results, you can export the X.-Y-Z coordinates, energy (keV), Bremstrahlung, and characteristic values for each point.

### Specimen Generator

MC X-Ray’s Specimen generator now includes options to generate specimens within pre-defined shapes, such as a cubes, cylinders within a cube, spherical inclusions, half and half compositions, and spheres on platform. Click the **Specimen** tab to view the options for generating specimens, as shown below.

Shape selections

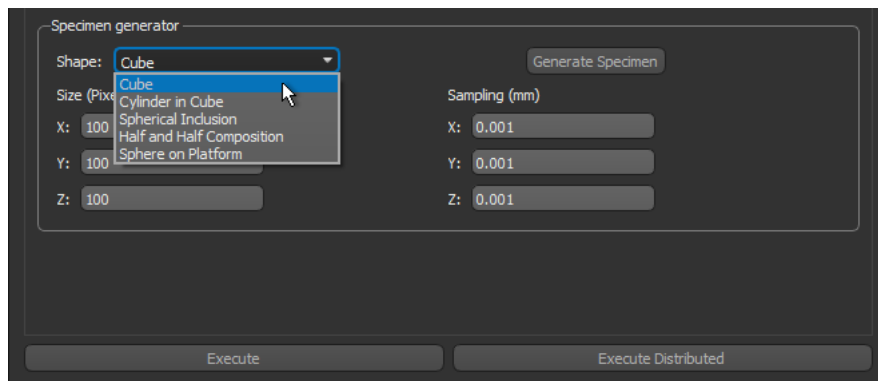

## Non-Planar Views

As a new option for Dragonfly 2021.3, you can create projections based on a selected sphere or cylinder as well as extract data from a curved plane. This means that 2D views are no longer limited to simple slices through an object. With the Non-Planar View mode, round or curved objects can now be unrolled or projected along their surface in a “flat” 2D view. This provides a new option for the characterization of internal geometries, for example in parts built by additive manufacturing (AM) or other processes.

You should note that the Non-Planar View mode is a standard feature for all Dragonfly licenses and that you can wrap all of the structured grids within a view — such as image data, regions of interest, and multi-ROIs — inside a sphere or cylinder or that intersect with a curved plane and then unwrap them in a non-planar 2D view.

Non-planar view (right) unwrapped from a cylindrical surface

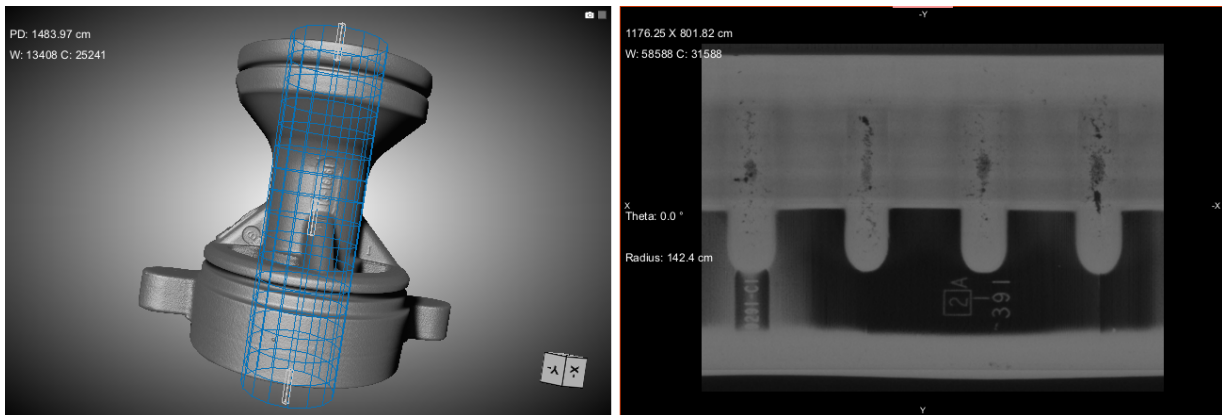

### Extracting Non-Planar Views from Spheres or Cylinders

Two non-planar views — **Sinusoidal** and **Equirectangular** — are available for projecting the surface of a sphere to a flat image (see [Spherical Projections](#) on page 46), while cylindrical projections represent meridians as straight, evenly-spaced vertical lines and circles of latitude (parallels) as straight horizontal lines (see [Cylindrical Projections](#) on page 46).

Do the following to extract a non-planar 2D view from a sphere or cylinder:

1. Add a Sphere or Cylinder shape to the workspace.  
**NOTE** In most cases, it is best to work in a workspace that includes both 2D reformatted views and a 3D view.
2. Adjust the shape with the transform controls so that the shape follows the surface that you want to inspect.
3. Select a view in the workspace.

- With the shape selected in Data Properties and Settings panel, choose **Non-planar 2D view** in the View mode drop-down menu in the Scene's Views Properties panel, as shown below.

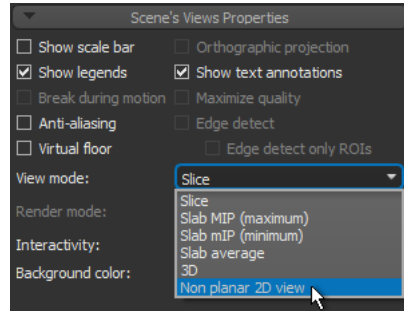

The non-planar view extracted from the surface of the sphere or cylinder appears.

**NOTE** The following additional interactive text annotations are available for manipulating non-planar views extracted from spheres and cylinders.

Annotation	Description
Theta	Lets you rotate the view around Theta (North Pole position).
Phi*	Lets you rotate the view around Phi (Equator position).
Radius	Lets you adjust the radius of the sphere or cylinder.
Projection*	Lets you toggle the view from Equirectangular to Sinusoidal and vice-versa (see <a href="#">Spherical Projections</a> on page 46).

\* For Spherical projections only.

### Cylindrical Projections

Cylindrical projections, as shown below, represent meridians as straight, evenly-spaced vertical lines and circles of latitude (parallels) as straight horizontal lines. In general, this projection is best for objects which can be completely enclosed and visible within a cylinder, without projecting or hollow parts.

### Spherical Projections

Two non-planar views — **Sinusoidal** and **Equirectangular** — are available for projecting the surface of a sphere to a flat image. You should note that spherical maps take into account the sphere's curvature, and each latitude line becomes evenly spaced. In general, these projections are best for objects which can be completely enclosed and visible within a sphere, without projecting or hollow parts.

Examples of the available spherical projections are shown in the following screen captures.

Sinusoidal (top right) and Equirectangular (bottom right) non-planar views unwrapped from a spherical surface

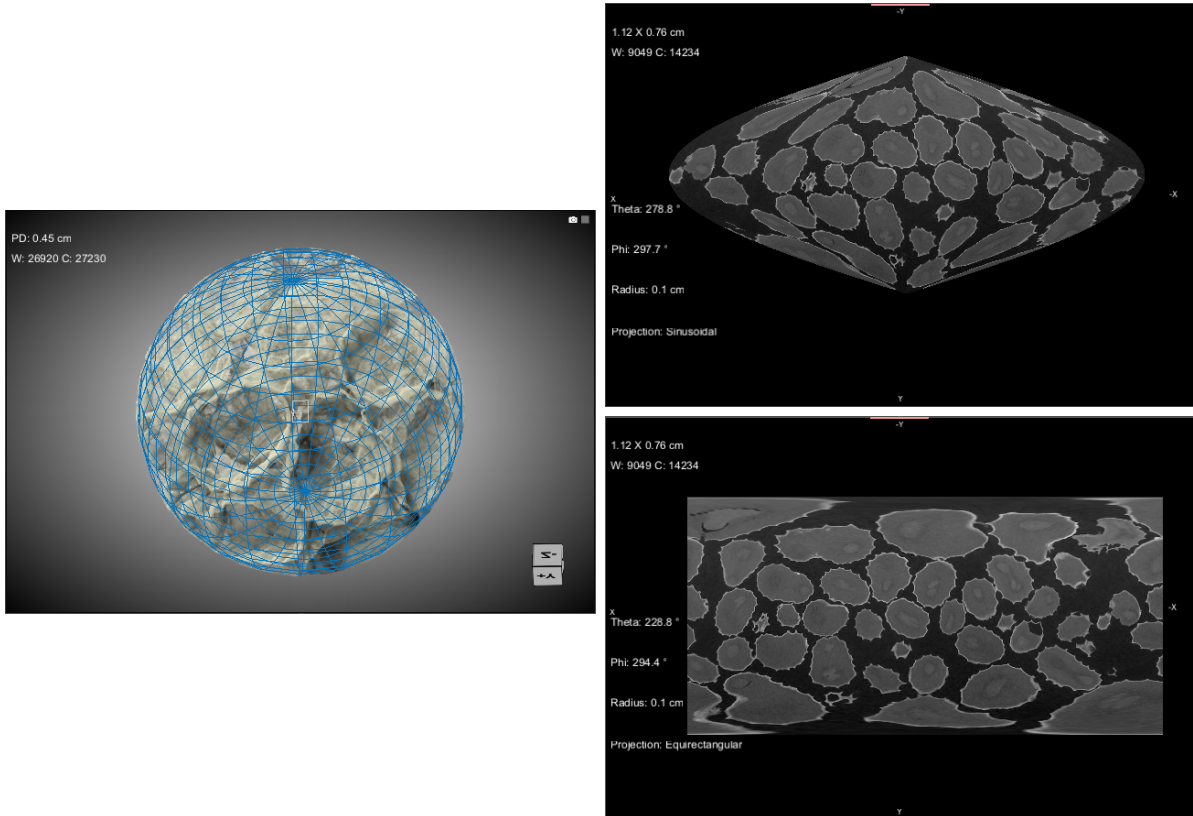

**Sinusoidal...** Is a pseudocylindrical, equal area projection in which equally spaced parallels and a central meridian are straight lines and the other meridians are sinusoidal curves, bulging away from the central meridian and equally spaced. Sinusoidal projections present accurate area and distance at every parallel and at the central meridian, while distortion increases at the outer meridians and at high latitudes. This is illustrated in the following diagram:

Distortion at the outer meridians and at high latitudes

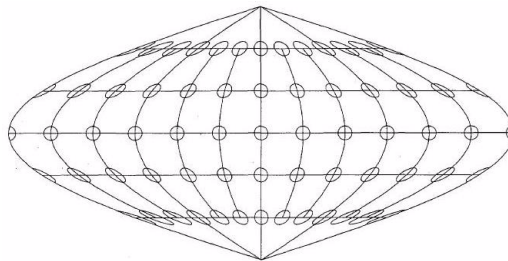

As shown in the above diagram, the equator and the central meridian are the most accurate parts of the projection, while distortion increases with distance from those parts.

**Equirectangular...** Also called the equidistant cylindrical projection, an equirectangular projection is a simple projection that maps meridians to vertical straight lines of constant spacing (for meridional intervals of constant spacing), and circles of latitude to

horizontal straight lines of constant spacing (for constant intervals of parallels). The projection is neither equal area nor conformal because of the distortions introduced.

### Extracting Non-Planar Views from Curved Planes

Dragonfly 2021.3 also includes the option to unroll tortuous planes using free form surface inspection tools, such as Bezier patches (shown below) and Radial Basis Function rectangles. With these tools, you can adjust the control points in 2D and 3D view, add control points, and extract data as a one-slice image for inspection and reporting.

Bezier patch

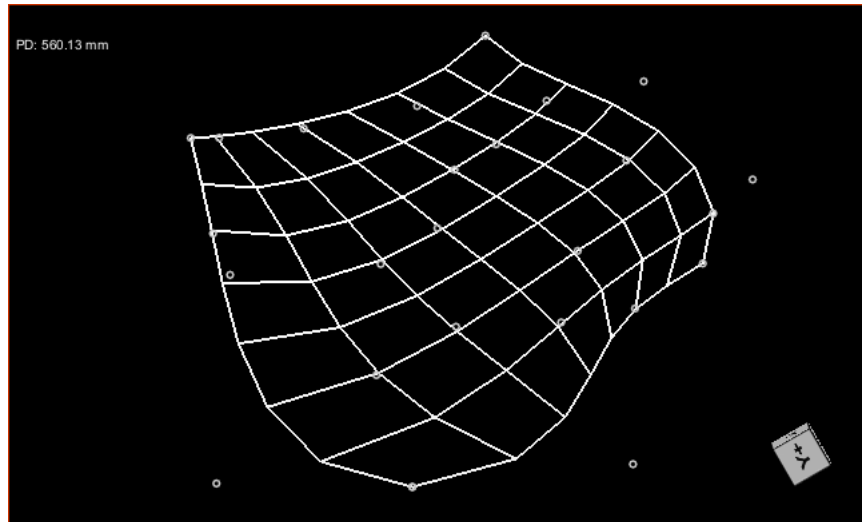

Do the following to extract a non-planar 2D view from a curved plane:

1. Draw a rectangle on the view that best corresponds to surface you want to inspect.

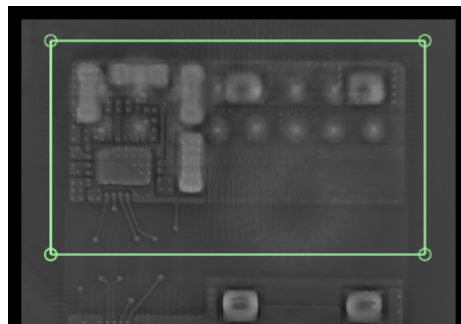

2. Right-click the annotation in the Data Properties and Settings panel and then choose **Create a Bezier Surface** or **Create a Radial Basis Function Surface** in the pop-up menu.

A Bezier patch or Visual RBF rectangle is added to the Data Properties and Settings panel.

3. In the 2D or 3D view, adjust the patch or rectangle with the control points so that it corresponds to the surface that you want to inspect.

**NOTE** You need to hold down LEFT CTRL to move a control point. This is the default for the configured action for 'Move the surface control points'.



**NOTE** You can redistribute and sample the control points while you work by right-clicking the patch or rectangle in the Data Properties and Settings panel and then choosing **Redistribute Control Points** in the pop-up menu.

**NOTE** You can also edit the shape properties — **Density**, which determines the number of lines in the grid, and **Thickness**, which determines the weight on the lines — in the Shape properties box, shown below.

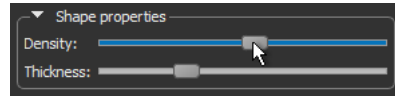

4. Select the view in the workspace in which you want to unroll the tortuous plane.
5. With the patch or rectangle selected in Data Properties and Settings panel, choose **Non-planar 2D view** in the View mode drop-down menu on the Scene's Views Properties panel, as shown below.

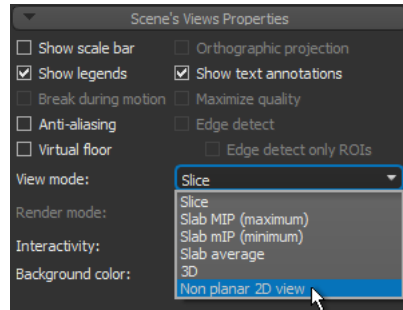

The non-planar view extracted from the surface of the curved plane appears.

**NOTE** If required, you can continue to modify the control points in the 2D or 3D view. The view of the curved plane will be updated in real time as you make your adjustments.

## Painting in Non-Planar Views

You can use the Brush and Point & Click ROI Painter tools in Multi-slice mode to label pixels in non-planar views. You should note that in this case, the painting sphere or cube will be aligned in world coordinates.

## Extracting Non-Planar Projections

If required, you can extract a non-planar projection as a 2D image for archiving or for further processing. This option is available in the Shape and Patch contextual menus.

Do the following to extract a projection as a 2D image:

1. Do one of the following:
  - Right-click the sphere or cylinder from which the projection was unwrapped.
  - Right-click the patch from the curved plane was extracted.
2. Choose **Extract Projection of Structured Grid** in the pop-up menu.

3. Select the required structured grid in the **Choose a Structured Grid to Extract** dialog, as shown below.

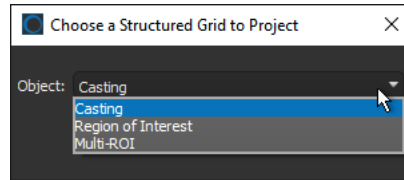

**NOTE** The structured grids you can extract data from include image data, regions of interest, and multi-ROIs.

4. Click **OK** to extract the projection.

When extracted, the new object appears in the Data Properties and Settings panel.

### Configured Actions for Non-Planar Views

The following actions can be configured for non-planar views in the Preferences dialog:

Configured actions for non-planar views

Action	Default key
Add or remove control points from Visual RBF rectangle	LEFT CTRL + Left mouse
Change projection mode	Left mouse
Manipulate the cylinder Theta offset	Left mouse
Manipulate the sphere north pole position Phi	Left mouse
Manipulate the sphere north pole position Theta	Left mouse

## 3D Renderings and 3D Views

A number of enhancements for 3D renderings and 3D views, which include reflective surfaces for virtual floors, optimizations for isosurfacing, improvements for applying focus, and options to shown the 3D cursor and 2D view planes in 3D views, are available in this software release.

**NOTE** This software release marks the deprecation of Dragonfly's legacy rendering engine.

### Virtual Floor

This software release includes the option to add reflective surfaces to 'virtual floors' in 3D views, as shown below.

Virtual floor with reflective surface



Check the **Virtual floor** option in the Scene's Views Properties panel to add the floor to the view and then check **Reflective surface** to add reflectivity. These options are circled on the screen capture below.

Virtual floor settings

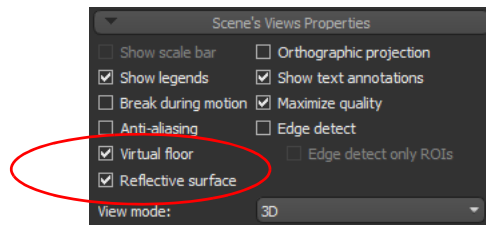

## Isosurface Renderings

This software release includes a number of optimizations for isosurfacing, which is a highly efficient visualization technique for extracting a surface from 3D volumetric data. By selecting an **Isovalue**, it is possible to visualize a surface corresponding to a particular tissue type or material. Below is an example of an isosurface extracted from a gothic prayer bead.

Isosurface rendering



Do the following to create an isosurface in a selected 3D view:

- Choose **ISO** as the Render mode in the Scene's Views Properties panel, as shown below.

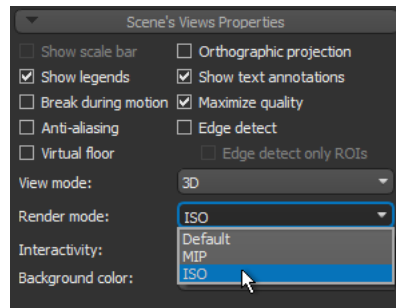

- Select a value with the **Isovalue** slider, as shown below, or enter a value in the Isovalue edit box. The Isovalue settings are available in the 3D settings box on the Data Properties and Settings panel.

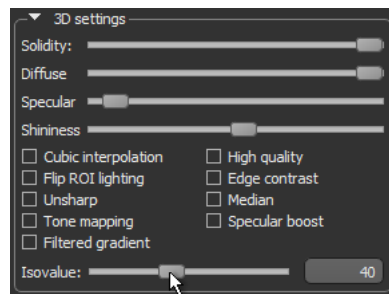

## Using Focus

A number of improvements are included in this Dragonfly release for applying focus to 3D renderings. As shown in the example below, unwanted halo effects and artifacts have been eliminated when blurring objects and features outside of focused region.

3D view with Focus enabled

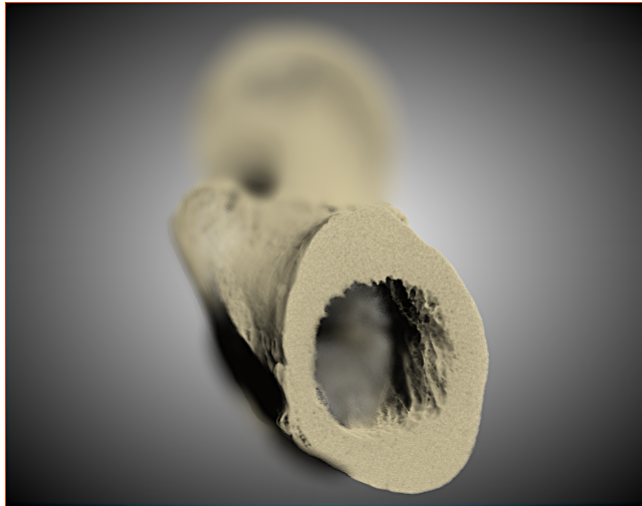

You should note that the Focus settings, shown below, are available on Scene's Views Properties panel

Focus settings

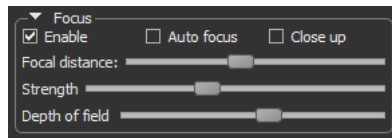

## Show 3D Cursor

The 3D cursor can now be shown in 3D views. Right-click inside the 3D view and then choose **Show 3D Cursor** in the pop-menu to enable the 3D cursor in the view, as shown below.

3D cursor

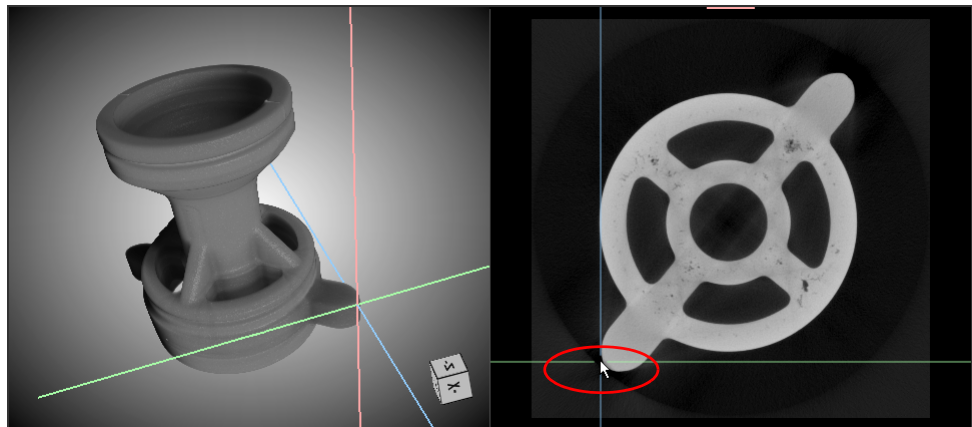

### Render 2D View Planes

This software release also includes the option to show 2D view planes in the 3D view. Right-click inside the 3D view and then choose **Show 2D View Plane(s)** in the pop-menu to enable the 2D view planes in the view, as shown. The plane or planes will appear when the 3D cursor is manipulated in any of the 2D views or if a 2D view is scrolled.

Rendered 2D view planes

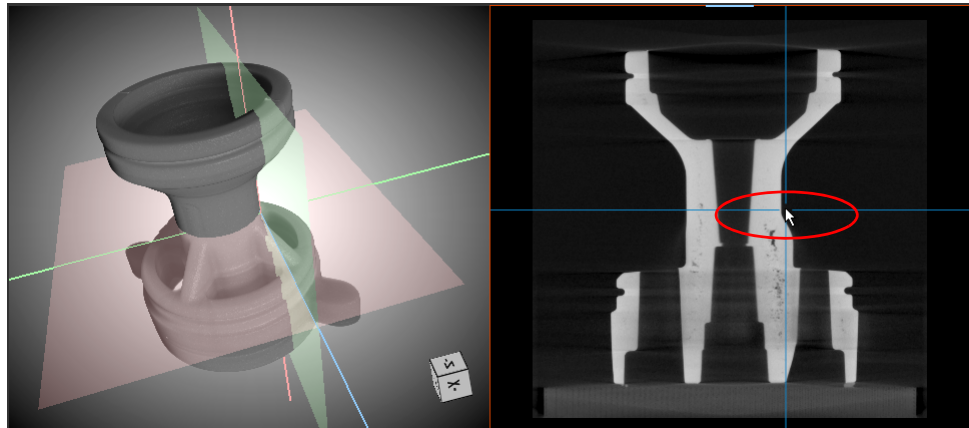

### Axis Indicator

A number of updates for the Axis Indicator, which indicates the orientation of 3D views, are included in Dragonfly 2021.3.

**Style...** When displayed as arrows, the Axis Indicator now includes titles for the orientation axes, as shown in the following screen capture.

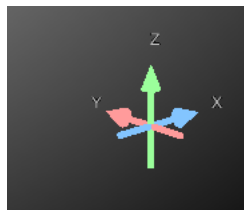

Right-click a 3D view and then choose **Axis Indicator > Arrows** in the pop-up menu to change the appearance of the Axis Indicator.

**Position...** You can now choose to position the Axis Indicator at the bottom right or bottom left corner of the 3D view. The options, which are circled on the following screen capture, are available in the Axis position box in the 3D Settings preferences.

Axis indicator preferences

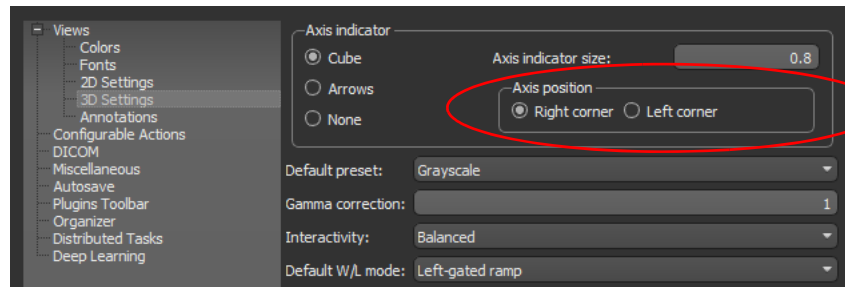

## Clipping

A number of new preferences and settings are available for clipping in this software release.

**Configurable axis lengths...** A new 3D Settings preference for the clip box — **Axis length factor (% of box)** — lets you choose an axis overshoot of the clip box, as shown below.

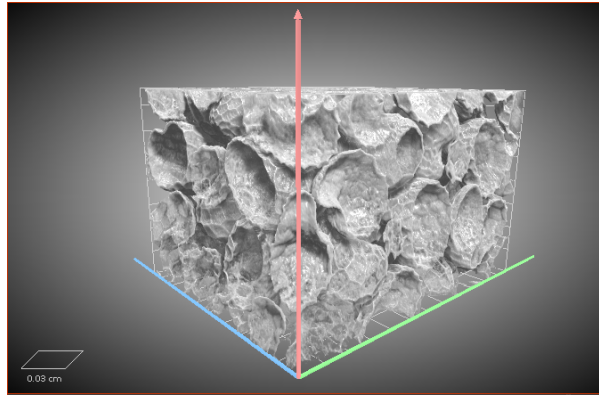

**Clip box visibility...** A new setting on the Data Properties and Settings panel, circled below, lets you choose to keep a clip box visible when the object to which it is associated is hidden.

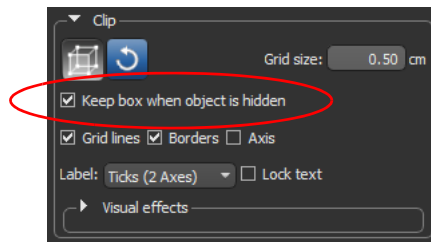

## Regions of Interest

---

The options to apply LUTs and smoothing to regions of interest, as well as improvements for visualizations of ROIs without image data, are available for Dragonfly 2021.3. In addition, the option to create images from the scalar values computed for a multi-ROI is also available in this software release.

### Applying LUTs

---

An additional visualization option for regions of interest is available in this software release. As shown in the following screen captures, you can apply a LUT to an ROI in 3D and 2D views.

ROI with solid color highlight (left) and with LUT applied (right)

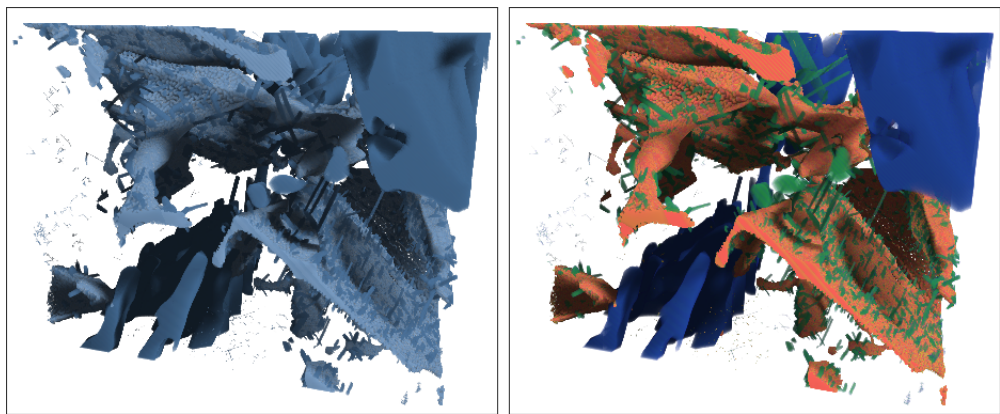

To apply a LUT to an ROI, select the option **Use LUT** in the Opacity and color box on the Data Properties and Settings panel, as shown below. You can then select the required LUT by clicking the corresponding color box in the Data Properties and Settings object list. LUTs will be available in the LUT dialog.

Opacity and color box

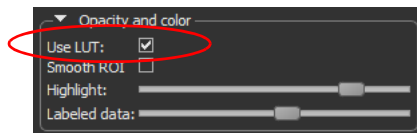

---

**NOTE** For both 2D and 3D views, colors of the applied LUT will be mapped to the underlying dataset values.

---

### Visualizations without Image Data

---

You should notice a marked improvement for visualizing regions of interest without a dataset. Regions of interest should now appear less pixelated with improved shading, as shown in the following screen capture.



ROI without a dataset

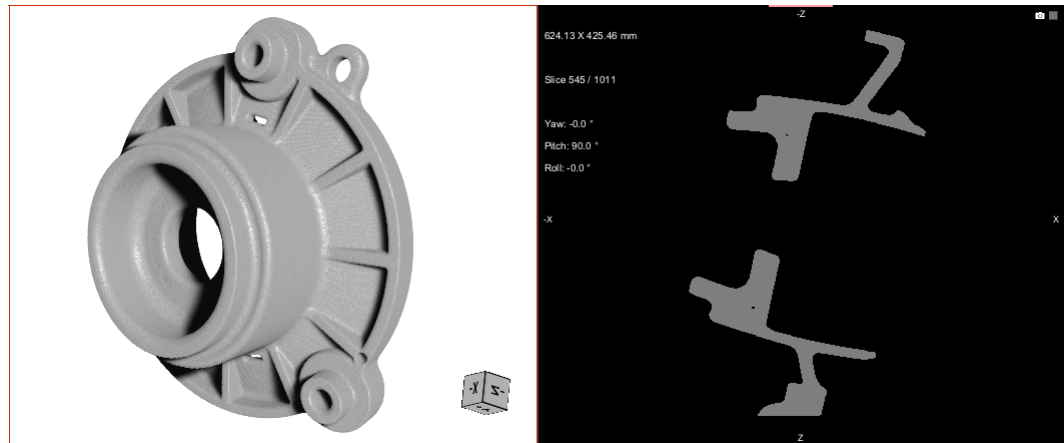

**Smoothing ROIs...** You can further improve visualizations of regions of interest that are shown without a dataset by smoothing. The option to apply smoothing is available in the Opacity and color box on the Data Properties and Settings panel, as circled below.

Opacity and color box

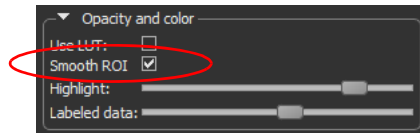

### Creating Images from Scalars

This software release includes the option to create images from the scalar values computed for a multi-ROI. For example, in cases in which you have done a connected components analysis. Right-click the required multi-ROI in the Data Properties and Settings panel and then choose **Create Images from Scalars** in the pop-up menu. You can then select the scalars from which you want to create your new images in the Select Scalars dialog, shown below.

Select Scalars dialog

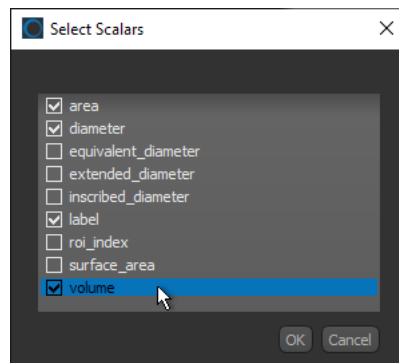

**NOTE** You can assign dimension units to images created from scalars (see [Image Properties \(Dimension Units\)](#) on page 30). For example, meters to diameters, m<sup>2</sup> to areas, and m<sup>3</sup> to volumes.

## ROI Painter

When using the ROI Painter tools, you can now view and edit the size of the brush on the ROI Painter panel.

Brush size

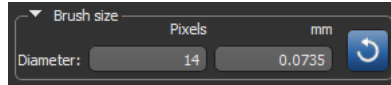

**NOTE** As of Dragonfly 2021.3, the highlight will not be shown in 3D views when painting until the mouse is released. In 2D views, the highlight will be updated continuously while painting.

## Graphs and Vector Fields

A level-of-detail (LOD) mechanism was implemented in this software release to help increase the speed of rendering for graphs and vector fields during manipulations. For graphs, the rendering of vertices is removed during movement while edges are still show. For vector fields, arrow heads are removed during movement.

To enable LOD for graphs, select the **Enable level of detail** option in the Graph settings box, as shown below.

Graph settings

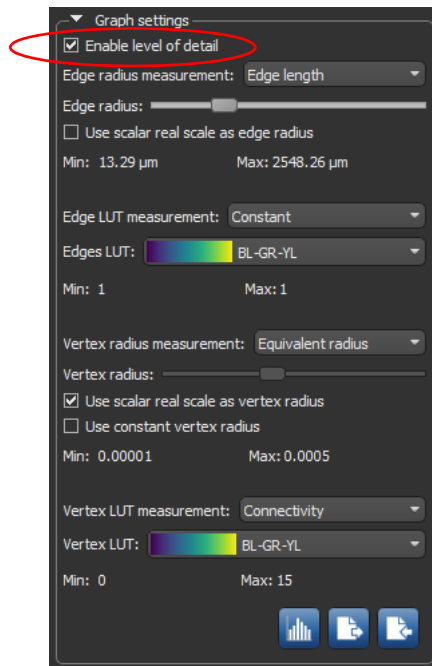

**NOTE** The level of detail mechanism is implemented at all times for vector fields.

## Meshes

---

A number of new options and updates for meshes, described below, are available in Dragonfly 2021.3.

### Thickness Analyses

---

An additional method is available in this software release for obtaining thickness values from the mesh of a single, closed 3D shape. In this directional method, known as normal ray tracing, a ray is passed normal to the mesh surface and its intersection with the opposite surface is computed to obtain the thickness value. The Euclidean (straight line) distance between the intersections is considered as the thickness at the given point.

Right-click a mesh in the Data Properties and Settings panel and then choose **Compute Ray-Tracing Thickness** to compute thickness with this method.

Thickness determination by normal ray-tracing

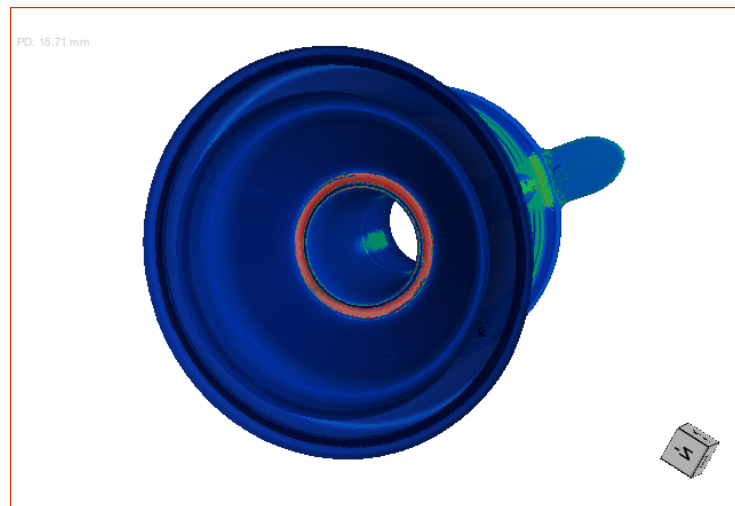

---

**NOTE** If the two surfaces containing the intersection points are not parallel, then the thickness values computed at the two opposite points will be different depending on the ray direction. This may lead to conflicting results for the pair of points.

---

**NOTE** Dragonfly also provides an alternate method for complex, organic geometries. This option, in which regions of interest are exported as thickness meshes and thickness is determined through inscribed spheres, is available on the ROI Tools panel.

---

### Mesh Capping

This software release also includes the option to cap meshes on the active clip box face. Check the **Cap mesh on active clipbox face** option, circled below, in the 3D settings box to cap a clipped mesh.

3D settings for meshes

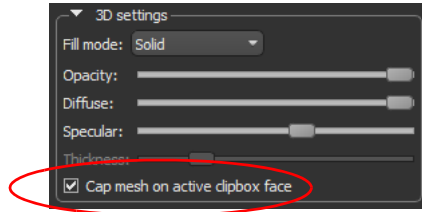

An example of the original clipped mesh and the capped version is available in the following screen captures.

Uncapped versus capped mesh

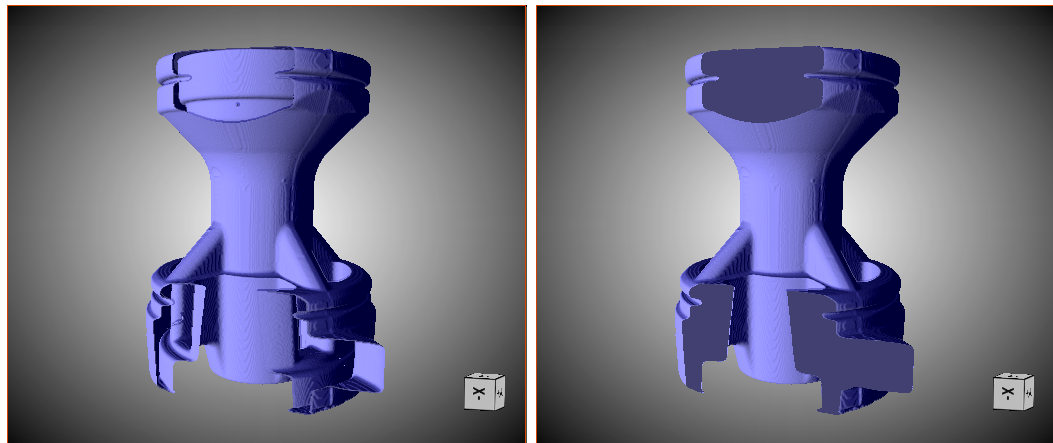

## Shapes

---

This software release includes the options to fit a sphere or cylinder to a series of points, as shown below.

Cylinder fit to points

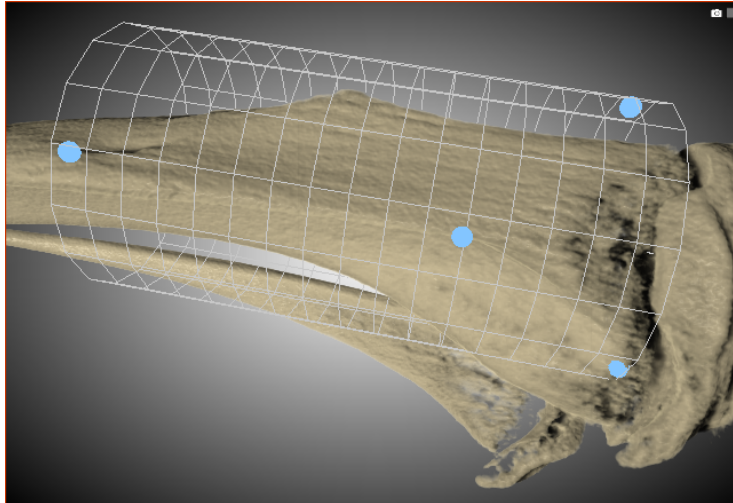

Do the following to create a new cylinder or sphere fitted to a series of points:

- Create a points set that describes the surface you want to enclose within a sphere or cylinder
- Right-click the points set and then choose **Fit a Cylinder from the Point Annotation** or **Fit a Sphere from the Point Annotation** in the pop-up menu.

A new cylinder or sphere is added to the Data Properties and Settings panel.

---

**NOTE** You will need a minimum of three points to fit a sphere to a points set and a minimum of six points to fit a cylinder to a points set.

---

---

**NOTE** Points can now be added and positioned in 3D views, in which they appear as spheres.

---

## Movie Maker

Updates for Dragonfly’s Movie Maker include additional bitrate options adapted for different needs. Click the **Export Animation** button on the Movie Maker panel to open the Export Animation dialog. The Bitrate options are shown in the screen capture below.

Export Animation dialog

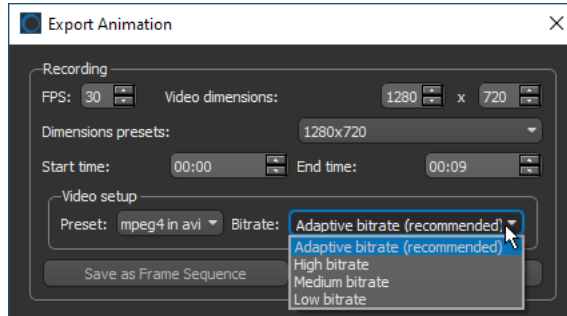

Bitrates, which determine the number of bits that are conveyed or processed per unit of time, are computed in Dragonfly’s Movie Maker as:

$$\text{bitrate} = [(\text{width} * \text{height} * \text{FPS}) * \text{motion factor} * \text{constant}] / 1000,$$

in which the motion factor varies on the selected quality and the constant is 0.15

Although higher bitrates generally result in better video quality, they will increase file size dramatically. You should choose a bitrate that is suitable for the amount of motion included within your animation.

**Adaptive bitrate...** The motion factor is set to 4 for this setting, which should be suitable for most videos.

**High bitrate...** The motion factor is set to 6 for this setting, which should be suitable for videos with high motion.

**Medium bitrate...** The motion factor is set to 2 for this setting.

**Low bitrate...** The motion factor is set to 1 for this setting.

## Screen Recorder

Now includes options to record audio with your microphone, as well to save a lower resolution file with the original recording.

Choose **Utilities > Screen Recorder** on the menu bar to open the Screen Recorder dialog, shown below.

Screen Recorder dialog

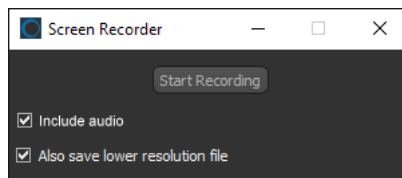

## Artificial Data Generator

The Artificial Data Generator lets you generate image data, regions of interest, and multi-ROIs for analysis, testing, and other purposes.

Choose **Utilities > Artificial Data Generator** on the menu bar to open the Create an Object dialog. You can choose to create an image, region of interest, or multi-ROI in the **Object type** drop-down menu.

The options for creating artificial image data are shown in the following screen capture.

Create an Object dialog for images

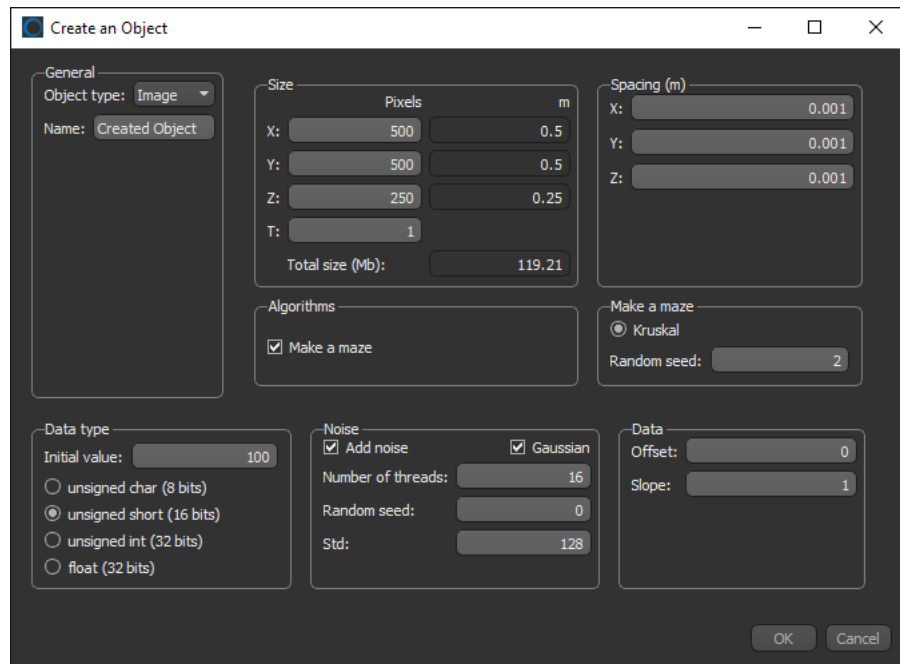

**NOTE** The **Create an Image** item in the File menu was deprecated in this software release. All of the options previously available in the Create an Image dialog are now available in the Create an Object dialog.

The options for creating regions of interest and multi-ROIs are shown in the following screen capture.

Create an Object dialog for ROIs and multi-ROIs

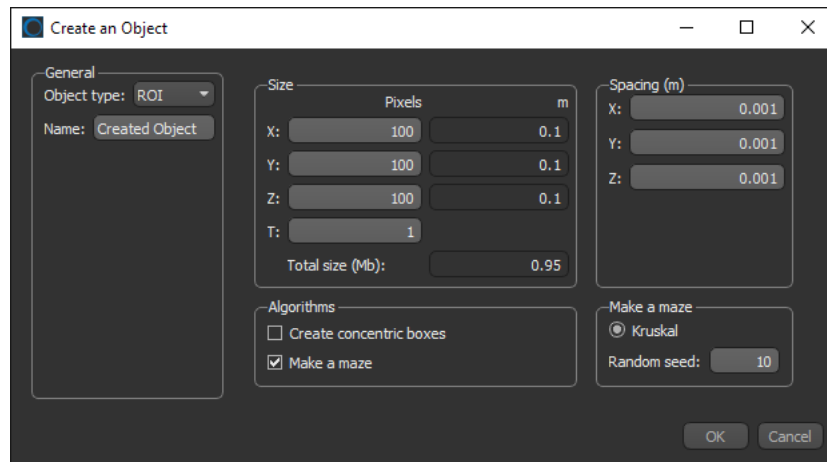

## Padding

This new option for Dragonfly 2021.3 lets you add padding to volumetric image data, regions of interest, and multi-ROIs. Right-click the required structured grid in the Data Properties and Settings panel and then choose **Modify and Transform > Padding** in the pop-up menu to open the Dataset Padding panel, shown below.

Dataset Padding panel

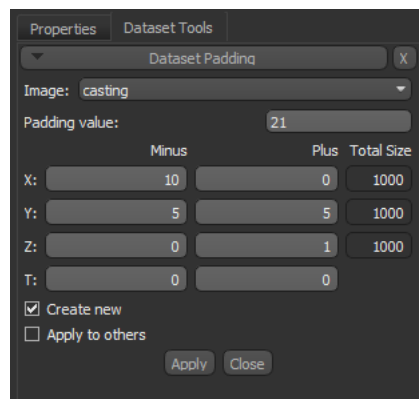

You can choose a value for the padded area voxels, as well as set padding to the plus and/or minus side of each axis.

**NOTE** You can also choose the pop-up menu item **Make a Padded Copy**. In this case, a series of dialogs will then appear that let you choose the padding for the X, Y, and Z axes, as well as a value for the added voxels.

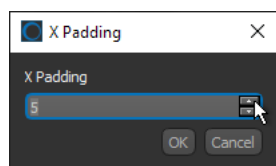



## CT Reconstruction

A number of updates for the CT Reconstruction module, which provides for the tomographic reconstruction of cone-beam and parallel-beam projections, are available in this software release. These include:

- YXLON metadata parser now supports multiple versions of metadata files from YXLON's FF 35 CT, MU2000-D, and Cheetah EVO X-ray and CT inspection systems.
- New metadata parser available for GE CT systems.
- New pre-processing phase retrieve filter for defective pixel correction.
- Support for parsing defective pixel maps from ROI files.
- Angular sampling for faster results when using 'Image metric' to find the center of rotation.

## Hyperspectral Imaging

This software release includes support for the LANL CXRF file format for Hyperspectral Imaging. You should note that confocal X-ray fluorescence microscopy (CXRF) can be used to acquire 3D depth profiling of the elemental composition of a sample.

## Customizing Workspaces

You can now choose to close a number of the workspace panels to optimize the space available on the left sidebar. Click the 'X' to close a workspace panel, as shown below.

Workspace panels



To reinstate a closed panel, choose **Utilities > Open Plugins** on the menu bar and then select the plugin you need to open.

**NOTE** The Window Leveling panel needs at least one instance at all times and you cannot close the last one.

## Menu Bar Changes

The following new items are available on the menu bar in Dragonfly 2021.3. Other changes are also listed here.

### File Menu

A number of changes, listed below, were implemented in the **File** menu.

File menu changes

	Description
Create an Image	This item was deprecated for Dragonfly 2021.3. The option to create an artificial image is now available in the Utilities menu (see <a href="#">Artificial Data Generator</a> on page 63).

### Artificial Intelligence Menu

A number of new items, listed below, are available in the **Artificial Intelligence** menu.

Artificial Intelligence menu changes

	Description
Filter with AI	Lets you apply deep learning regression models that you trained, imported, or downloaded for denoising and super resolution tasks (see <a href="#">Filter with AI</a> on page 25).

### Utilities Menu

A number of new items, listed below, are available in the **Utilities** menu.

Utilities menu changes

	Description
Dimension Unit Manager	Lets you create new units and calibration standards for intensity scale calibrations (see <a href="#">Dimension Unit Manager</a> on page 29).
Artificial Data Generator	Lets you generate image data, regions of interest, and multi-ROIs for analysis, testing, and other purposes (see <a href="#">Artificial Data Generator</a> on page 63).

## Changes to Contextual Menus

The following changes for the contextual menus available in the Data Properties and Settings panel are implemented in Dragonfly 2021.3.

### Dataset Pop-Up Menu

A number of new items, listed below, are available in the **Dataset** pop-up menu.

Dataset pop-up menu changes

	Description
Modify and Transform	A new item available in the submenu, <b>Padding</b> , lets you add padding to a dataset (see <a href="#">Padding</a> on page 64).
Filter with AI	Lets you apply deep learning regression models that you trained, imported, or downloaded for denoising and super resolution tasks (see <a href="#">Filter with AI</a> on page 25).
Make a Padded Copy	Lets you make a copy of the selected image data with padding on the X, Y, and Z axes (see <a href="#">Padding</a> on page 64).
Calibrate Intensity Scale	Lets you calibrate an image to a set of calibration standards (see <a href="#">Intensity Scale Calibrations</a> on page 28).
Calibrate Spatial Scale	Lets you define the spatial scale so that measurement results are presented with the correct values (see <a href="#">Spatial Scale Calibrations</a> on page 31).

### ROI Pop-Up Menu

A number of new items, listed below, are available in the **ROI** pop-up menu.

ROI pop-up menu changes

	Description
Modify and Transform	A new item available in the submenu, <b>Padding</b> , lets you add padding to a region of interest (see <a href="#">Padding</a> on page 64).
Make a Padded Copy	Lets you make a copy of the selected region of interest with padding on the X, Y, and Z axes (see <a href="#">Padding</a> on page 64).
Calibrate Spatial Scale	Lets you define the spatial scale so that measurement results are presented with the correct values (see <a href="#">Spatial Scale Calibrations</a> on page 31).

### Multi-ROI Pop-Up Menu

A number of new items, listed below, are available in the **Multi-ROI** pop-up menu.

Multi-ROI pop-up menu changes

	Description
Modify and Transform	A new item available in the submenu, <b>Padding</b> , lets you add padding to a multi-ROI (see <a href="#">Padding</a> on page 64).
Create Images from Scalars	Lets you create images from the scalar values computed for a multi-ROI (see <a href="#">Creating Images from Scalars</a> on page 57).
Make a Padded Copy	Lets you make a copy of the selected multi-ROI with padding on the X, Y, and Z axes (see <a href="#">Padding</a> on page 64).
Scalar Generator	Lets you compute basic measurements, measurements extracted from a dataset, as well as add other values, such as the number of voxels intersecting with another object (see <a href="#">Scalar Generator</a> on page 32).

	Description
Calibrate Spatial Scale	Lets you define the spatial scale so that measurement results are presented with the correct values (see <a href="#">Spatial Scale Calibrations</a> on page 31).

## Mesh Pop-Up Menu

A number of new items, listed below, are available in the **Mesh** pop-up menu.

Mesh pop-up menu changes

	Description
Compute Ray-Tracing Thickness	Lets you obtain thickness values using the normal ray tracing method (see <a href="#">Thickness Analyses</a> on page 59).
Scalar Generator	Lets you add measurements, scalar values, and constants (see <a href="#">Scalar Generator</a> on page 32).

## Graph Pop-Up Menu

A number of new items, listed below, are available in the **Graph** pop-up menu.

Graph pop-up menu changes

	Description
Scalar Generator	Lets you add measurements, scalar values, and constants (see <a href="#">Scalar Generator</a> on page 32).

## Vector Field Pop-Up Menu

A number of new items, listed below, are available in the **Vector Field** pop-up menu.

Vector Field pop-up menu changes

	Description
Scalar Generator	Lets you add measurements, scalar values, and constants (see <a href="#">Scalar Generator</a> on page 32).

## Annotations Pop-Up Menu

A number of new items, listed below, are available in the **Annotations** pop-up menu.

Annotations pop-up menu changes

	Description
Create a Bezier Surface*	Creates a Bezier patch, which can be adjusted and then unrolled in a non-planar view (see <a href="#">Extracting Non-Planar Views from Curved Planes</a> on page 48).
Create a Radial Basis Function Surface*	Creates a Visual RBF rectangle, which can be adjusted and then unrolled in a non-planar view (see <a href="#">Extracting Non-Planar Views from Curved Planes</a> on page 48).

\* For rectangular regions only.

## Shapes Pop-Up Menu

A number of new items, listed below, are available in the **Shapes** pop-up menu.

Shapes pop-up menu changes

	Description
Extract Projection of Structured Grid*	Lets you extract a non-planar projection from a dataset as a 2D image for archiving or for further processing (see <a href="#">Extracting Non-Planar Projections</a> on page 49).
Redistribute Control Points**	Lets you resample and/or redistribute the control points for Bezier patches and Visual RBF rectangles.

\* For cylinders, spheres, Bezier patches, and Visual RBF rectangles.

\*\* For Bezier patches and Visual RBF rectangles only.

## Preferences Changes

A number of new items, listed below, and other changes have been implemented for setting the application preferences.

Click **Preferences** on the Status bar or choose **File > Preferences** on the Menu bar to open the Preferences dialog.

### Views Preferences

Changes for the **Views** preferences are indicated in the following table.

Views preferences changes

	Description
<b>3D Settings</b>	
Axis indicator	Includes a new option for setting the position of the Axis indicator — 'Right corner' or 'Left corner'.
Clip box	Includes the new setting <b>Axis length factor (% of box)</b> for setting an axis overshoot of the clip box (see <a href="#">Clipping</a> on page 55).
Depth sorting when using shapes	Item deprecated. A new option, 'Accurate depth sorting', in the 3D settings panel replaces this preference.
<b>Annotations</b>	
Scale bar	Includes the new scale bar properties that can be set as preferences (see <a href="#">Scale Bar Properties</a> on page 41).
Rulers	Includes the new ruler properties that can be set as preferences (see <a href="#">Ruler Properties</a> on page 37).
Arrows	Includes the new arrow properties that can be set as preferences (see <a href="#">Arrow Properties</a> on page 40).

### Organizer Preferences

Changes for the **Organizer** preferences are indicated in the following table.

Organizer preferences changes

	Description
Items shown in recent projects list	Lets you set the maximum number of items that will be shown in the <b>Recent</b> list (see <a href="#">Organizer</a> on page 6).

## Configurable Actions

New configurable actions are available for working with the surface inspection tools and opening plugins. Chose **File > Preferences > Configurable Actions** to access the configurable actions for Dragonfly.

New configurable actions

Action	Default Configuration
<b>For non-planar views</b>	
Add a control point to Visual RBF rectangle	<i>Not defined</i>
Change projection mode	Left mouse
Manipulate the cylinder Theta offset	Left mouse
Manipulate the sphere north pole position Phi	Left mouse
Manipulate the sphere north pole position Theta	Left mouse
Move the surface control points	LEFT CTRL + Left mouse
Remove a control point fro Visual RBF rectangle	<i>Not defined</i>
<b>Miscellaneous</b>	
Go to Previous Non-Empty Slice of ROI, Multi-ROI or Image (Image Plane Only)	Right
Open Macro Player	<i>Not defined</i>

## Deep Learning Preferences

A new set of Deep Learning preferences are available in Dragonfly 2021.3 to enable the checkpoint cache option and to set the size limits for the cache.

Deep Learning preferences

	Description
GPU card for Deep Learning	Lets you choose a specific GPU card for Deep Learning.
Enable checkpoint cache	<p>Check this item to enable the checkpoint cache, which lets you load and then save a model at a selected checkpoint (see <a href="#">Loading and Saving Model Checkpoints</a> on page 23).</p> <p><b>Maximum cache disk space per model...</b> Lets you set the per model limit for the cache disk space.</p> <p><b>Total cache disk space usage...</b> Indicates the total size of the checkpoint cache. If required, you can clear the checkpoint cache by clicking <b>Clear cache</b>.</p>

## Resolved Issues

A number of issues reported by users have been resolved in this software release. These include the following:

- Issues with Brush cursor for painting when working remotely or on Linux have been resolved.
- Issues with the Screen Recorder have been resolved. Originally reported for the Beta version of Dragonfly 2021.3.
- The scale bar is now shown in the correct size in screenshots that are exported at higher resolutions than the screen.
- Dragonfly 2021.3 includes support for RTX3000 cards for Deep Learning.

## System Requirements

This release supports the base system requirements for Windows.

For the Linux version, supported operating systems now start from Ubuntu 18.04 (see <http://www.theobjects.com/dragonfly/system-requirements.html>).

## Third-Party Packages

---

You should note that the third-party packages listed below were updated for this release:

Updated third-party packages

Item	2021.3	Previous release
TensorFlow	2.4.1	1.14.0
Qt	5.12.9	5.9
Python	3.8.6	3.7.3

## Publicly Available Source Code

Users can freely download and examine the source code of the following.

### TensorFlow

---

A number of Dragonfly's artificial intelligence applications, such as the Deep Learning Tool, the Segmentation Wizard, and Segment with AI, use TensorFlow APIs to facilitate training and inference of deep neural networks. Created by the Google Brain team, TensorFlow is a free and open-source library widely used for deep learning applications and traditional machine learning.

Users can freely download and examine the TensorFlow source code from:

<https://github.com/tensorflow/tensorflow/releases/tag/v2.4.1>.

### Qt

---

Dragonfly is designed and developed with Qt, which is a free and open-source toolkit for creating graphical user interfaces and cross-platform applications. Qt is developed by The Qt Company, a publicly listed company, and is available under both commercial licenses and open-source GPL 2.0, GPL 3.0, and LGPL 3.0 licenses.

Users can freely download and examine the Qt source code from:

[https://download.qt.io/official\\_releases/qt/5.12/5.12.9/](https://download.qt.io/official_releases/qt/5.12/5.12.9/).



## Extending Dragonfly

Dragonfly's Infinite Toolbox, an open exchange platform for the Dragonfly user community, lets you submit, browse, and download extensions that implement new features and workflows for all of your image processing or analysis needs.

Choose **Utilities > Infinite Toolbox** on the menu bar to open Dragonfly's Infinite Toolbox.

## Requesting New Features

Let us know if you have a suggestion for a new feature, or an idea for an improvement to an existing workflow.

## Learning Dragonfly

You'll find some great free resources, such as our latest instructional videos, recorded webinars, and user forums just by taking a quick look around [www.theobjects.com/dragonfly/](http://www.theobjects.com/dragonfly/). You can also take advantage of the course offerings listed below to further benefit from our training team's in-depth product knowledge.

### Dragonfly Workshops

---

Our hands-on training workshops are a great way to get up and running quickly. Combining in-depth instruction with class exercises, our product specialists will quickly teach you how to use key Dragonfly features and functions to optimize your image visualization and analysis tasks.

---

**NOTE** All scheduled Dragonfly workshops have been postponed or cancelled due to worries about the coronavirus pandemic. We will resume our workshop schedule as soon as possible. You can check for updates at <http://www.theobjects.com/dragonfly/workshops.html>.

---

### Online Training

---

Get connected with an online training session and follow along with a Dragonfly product specialist as they demonstrate the features and benefits of Dragonfly and walk you through specialized modules. Web-based training, which can be adapted to individual needs and interests, offers an interactive approach that lets you practice new techniques on numerous case studies.

---

**NOTE** Online training is available upon request. Contact [support@theobjects.com](mailto:support@theobjects.com) for information about availability.

---

## Reporting Issues

Dragonfly includes an integrated reporting module that lets you include comments and other information along with generated DMP and log files whenever you encounter an issue that results in a crash or application freeze.

Send Report to ORS dialog

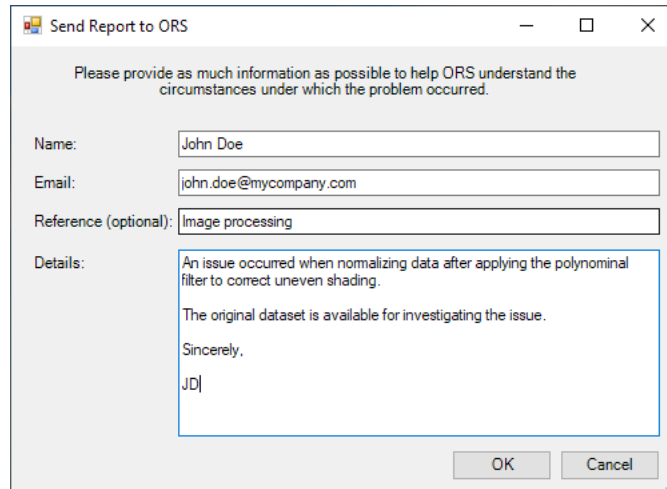

Please provide as much information as possible to help ORS understand the circumstances under which the problem occurred.

Name:

Email:

Reference (optional):

Details:

OK Cancel

You should note that you can also report an issue at any time by choosing **Help > Report an Issue** on the menu bar.